

LA-9124-MS

c. 3

CIC-14 REPORT COLLECTION
REPRODUCTION
COPY

Los Alamos National Laboratory is operated by the University of California for the United States Department of Energy under contract W-7405-ENG-36.

*Test and Evaluation of the
In-Line Plutonium Solution
K-Absorption-Edge Densitometer
at the Savannah River Plant*

Phase I, Off-Line Testing Results

LOS ALAMOS NATIONAL LABORATORY
3 9338 00312 7080

Los Alamos Los Alamos National Laboratory
Los Alamos, New Mexico 87545

This work was supported by the US Department of Energy, Office of Safeguards and Security.

Edited by Katherine H. Harper
Word processing and preparation by Jo Ann Barnes

DISCLAIMER

This report was prepared as an account of work sponsored by an agency of the United States Government. Neither the United States Government nor any agency thereof, nor any of their employees, makes any warranty, express or implied, or assumes any legal liability or responsibility for the accuracy, completeness, or usefulness of any information, apparatus, product, or process disclosed, or represents that its use would not infringe privately owned rights. References herein to any specific commercial product, process, or service by trade name, trademark, manufacturer, or otherwise, does not necessarily constitute or imply its endorsement, recommendation, or favoring by the United States Government or any agency thereof. The views and opinions of authors expressed herein do not necessarily state or reflect those of the United States Government or any agency thereof.

LA-9124-MS

UC-15

Issued: April 1982

Test and Evaluation of the In-Line Plutonium Solution K-Absorption-Edge Densitometer at the Savannah River Plant

Phase I, Off-Line Testing Results

H. A. Smith, Jr.
T. Marks
S. S. Johnson
L. R. Cowder
J. K. Sprinkle, Jr.
C. O. Shonrock
R. W. Slice
D. L. Garcia

and

K. W. MacMurdo*
R. L. Pollard*
L. B. Baker*
P. Christie*
J. P. Clark*



*E. I. DuPont de Nemours and Co., Savannah River Plant, Aiken, SC 29801

Los Alamos Los Alamos National Laboratory
Los Alamos, New Mexico 87545

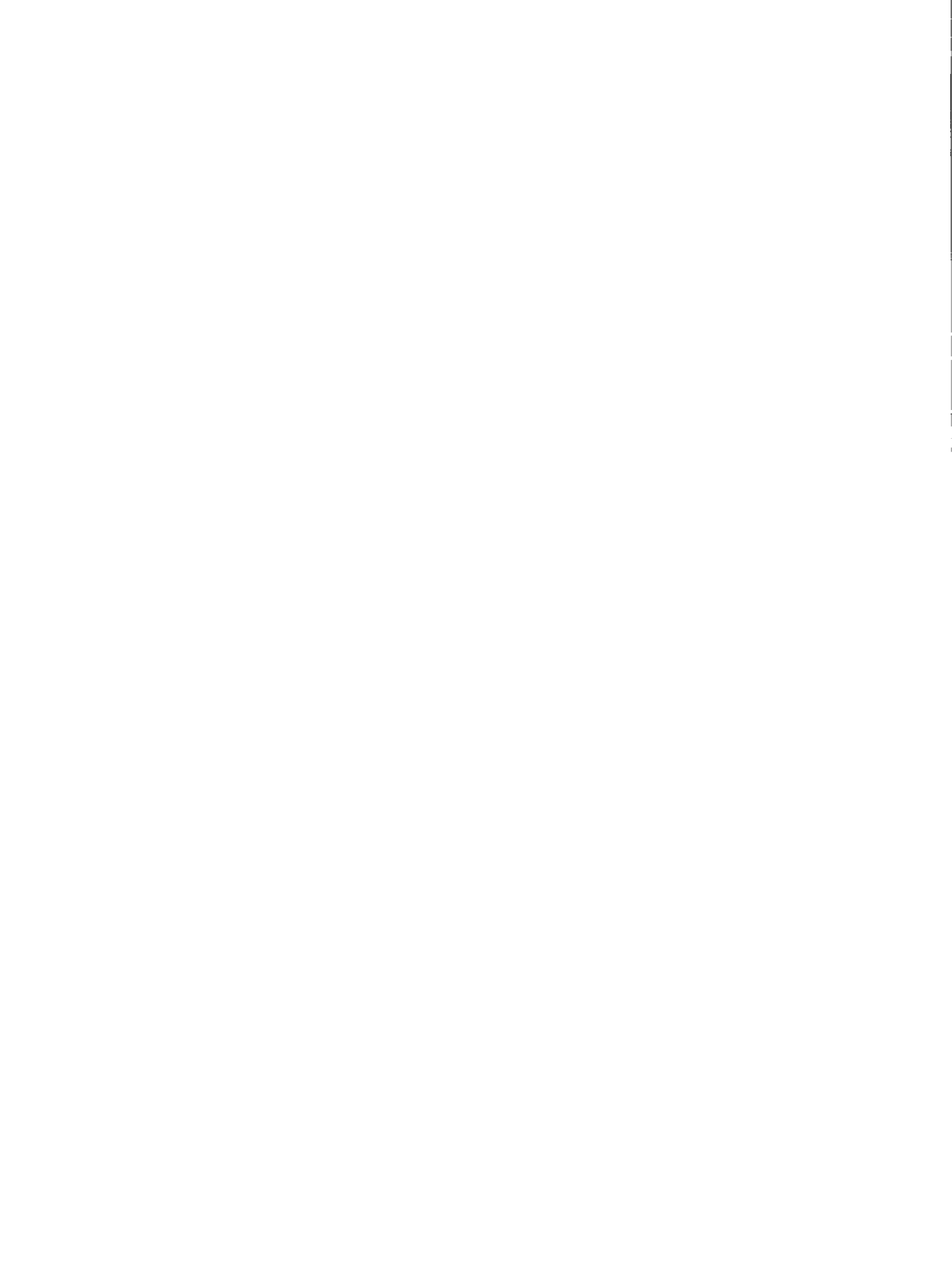

CONTENTS

ABSTRACT	1
I. INTRODUCTION	2
A. Background	2
B. Basic Physics of the Measurements	3
1. Plutonium Densitometry	3
2. Plutonium Isotopic Analysis	7
3. Heavy-Element Matrix Corrections	9
II. INSTRUMENT DESIGN FEATURES	10
A. Measurement Station	10
B. Densitometer Solution Plumbing System	13
C. Densitometer Electronics	17
1. The Gamma-Ray Detector	17
2. Modular Pulse-Processing and Hardware Electronics	17
D. Computer Software	18
1. Hardware Management	19
2. Data Acquisition and Performance Monitoring . .	20
3. Data Analysis	22
4. Measurement Control	23
a. Instrument Calibration	23
b. Measurement of Unattenuated Photon Intensities and Background	25
c. Standard Foil Measurements	26
5. General Software Features and Special Operational Modes	27
III. CALIBRATION AND PERFORMANCE IN DESIGN CONCENTRATION RANGE	28
A. Back-Up Chemical Preparation and Analysis	28
1. Preparation of Solution Standards	28
2. Analysis of the Process Solutions	29

B.	Assay of Calibration Standards and Comparison with Chemistry	31
C.	Measurement-Control Results	33
D.	Isotopics Measurements	33
E.	Performance of the Solution Plumbing System	37
IV.	EXTENSION OF RANGE OF OPERATION	37
A.	Introduction	37
B.	Extended Plutonium Concentration Range	39
C.	Plutonium Assay of Solutions with Uranium Admixtures	44
V.	SUMMARY	48
	ACKNOWLEDGMENTS	48
	APPENDIX A: FORMULATION OF THE K-EDGE PLUTONIUM DENSITOMETRY ASSAY	49
	APPENDIX B: PLUTONIUM ISOTOPIC ANALYSIS	59
	REFERENCES	62

LIST OF TABLES

Table I.	Correct Settings of the Ten Valves and Pump in the In-Process By-Pass Solution Loop for the SRP K-Edge Densitometer, for the Nine Allowed Solution Flow Modes	. . . 21
Table II.	List of Gamma-Ray Peaks used in the Assays and Isotopic Analyses Performed by the SRP K-Edge Densitometer	. . . 26
Table III.	Summary of SRP Densitometer Solution Standards Prepared for the Off-Line Test and Evaluation Phase of the Instrument	. . . 30
Table IV.	Summary of Plutonium Isotopics Declared for Batches Analyzed by the SRP K-Edge Densitometer During the Off-Line Phase of the Test and Evaluation	. . . 35



LIST OF FIGURES

- Fig. 1. Upper Portion: An expanded view of the photon absorption probability as a function of photon energy, shown in the energy region of the plutonium-K-absorption edge. Also shown for purposes of comparison is the absorption probability for water over the same energy range. Lower Portion: A schematic representation of the incident (solid curves) and transmitted (dotted curves) photon intensities for two photon photopeaks, one just above the plutonium K edge and one just below the edge. Note the dramatically higher absorption of the photon intensity above the plutonium K edge. The energy spacing of the two peaks is exaggerated for purposes of clarity. The actual energy spacing is indicated by the arrows at the top of this portion of the figure. . . . 4
- Fig. 2. A representation of a typical experimental setup for measurement of photon transmission by a sample. The photon source is collimated and the detector views transmitted gamma rays that have traversed a distance x through the sample. . . . 6
- Fig. 3. The gamma-ray spectrum from a sample of low-burnup plutonium, showing the gamma-ray peaks in the energy range 120-175 keV. The isolated peaks from ^{238}Pu , ^{239}Pu , ^{241}Pu are highlighted in the figure. Also shown is a multiplet, containing gamma-ray intensity from ^{240}Pu . These data are not used in the isotopic analysis because the ^{240}Pu component cannot be extracted with high precision. . . . 8
- Fig. 4. Schematic of the collimator and source wheel arrangements relative to the sample cell and gamma-ray detector. Each gamma-ray spectrum is measured separately by rotation of the proper source/collimator combination into position. The tungsten collimator wheel shields the detector from the radiation from the sources that are not in use. . . . 11
- Fig. 5. Schematic of the in-line installation configuration for the plutonium solution densitometer at the Savannah River Plant. A bypass solution plumbing loop is shown, which brings plutonium-bearing solution from one of the holding tanks in the process cabinet to a measurement cell located in a small extension to the process cabinet containment. The measurement station (shown in more detail in Fig. 6) is placed over this extension so that the sample cell sits between the transmission sources and the gamma-ray detector. Provision is made in the plumbing circuit for the draining of the sample cell into an intermediate reservoir so that samples of the material just assayed can be removed for off-line assay/verification by chemical and mass-spectroscopic techniques. . . . 12

Fig. 6. Illustration of the measurement station for the in-line plutonium solution densitometer currently undergoing test and evaluation at the Savannah River Plant. The mechanism for movement of the source and collimator wheels (shown at the left) straddles the process cabinet extension so that the sample cell (inside the process cabinet containment) is between the transmission sources and the detector in the standard transmission-measurement geometry. The liquid nitrogen dewar for the gamma-ray detector is shown at the right, and the detector views the sample cell from the right, through the walls of the process cabinet extension. The entire assembly is currently installed in a plutonium solutions glove box, off-line in the SRP labs area. In the in-line configuration, this assembly will be supported approximately 2 m from floor level on a shelf attached to the process-cabinet support structure (Fig. 5).

. . . 14

Fig. 7. Photo of the plutonium K-edge densitometer as installed at the Savannah River Plant for off-line measurements. The measurement station (see Fig. 6) is positioned over an extension of the glove box surface in a manner analogous to the intended in-line configuration. Pulse-processing and data analysis equipment are shown adjacent to the measurement station.

. . . 15

Fig. 8. Schematic of the in-line plumbing circuit for the K-edge densitometer at the Savannah River Plant. Automatic valves are activated by computer-generated commands, based upon the type of assay task requested. Manual valves are set by the operator. All valves are sensed by the computer to verify that all settings are correct for the task required. For the current set of acceptable valve settings, see Table I.

. . . 16

Fig. 9. An example of the printed summary of the assay results for the Savannah River Plant K-edge densitometer. In this example, the plutonium concentration and the isotopic composition were requested for the solution in tank C-7(C). Furthermore, the operator (identified as 04860) requested 56 consecutive assays of the same sample and designated that the spectra from the last cycle be recorded on the floppy disk for archival data storage. The sample ID (in line 3) and the file name of the recorded data (C09MAY.02) are constructed by the software from its own knowledge of the date and time of the assay and the assay request information given by the operator. Note also that the temperatures of the sample solution (CELL), the pulse-processing electronics (NIM-BIN), and the densitometer computer (LSI-11) are provided. In addition, if any of the diagnostics checks by the computer have failed, reminders of the failed tests are printed in this summary to emphasize the possibly questionable value of the results quoted. (These reminders continue to be repeated in subsequent assays until the tests in question are passed successfully.)

. . . 24

Fig. 10. Comparison of densitometry results with chemical analyses for instrument assays of Standards I, II, and III during the extended calibration exercise. Each data point stands for the average of several repeated (autocycled) assays of individual portions of each standard. The error bars represent the standard deviation of the mean of each autocycled run. The mean value of all deviations shown in the figure is $-0.026 \pm 0.036\%$ 32

Fig. 11. A summary of all of the individual assays of the standard plutonium foil over the 8-month period from May 1980 to December 1980. The rms scatter of the assay points is within 0.5% of the average foil assay value of 29.375 g Pu/L (effective). The error bars indicate the quoted statistical precision of an individual measurement ($\pm 0.3\%$). . . . 34

Fig. 12. A comparison of $^{238}\text{Pu}/^{239}\text{Pu}$ and $^{241}\text{Pu}/^{239}\text{Pu}$ isotopic ratios measured by the K-edge densitometer with the SRP mass spectrometry values for the two isotopic batches measured to date. These results appear to be free of any significant batch-to-batch fluctuations but show small measurement biases. Appropriate adjustment of the detection efficiency calibration constants will remove these biases. This adjustment will be performed in preparation for the in-line test and evaluation measurements. Data points are plotted in chronological order, and the standard numbers to which they correspond are shown at the bottom of the figure. . . . 36

Fig. 13. A comparison of the K-edge-densitometer isotopics analysis with SRP mass spectrometry for the $^{239},^{240}\text{Pu}$ absolute-weight fractions. The batch-to-batch fluctuations in these data (in contrast to the measured isotopic ratios) are a probable indication of the inherent precisions of the isotopic correlations used in the analysis of the data. These fluctuations indicate approximate precisions for the ^{239}Pu and the ^{240}Pu determinations of the $\pm 0.4\%$ and $\pm 3.0\%$, respectively. Data points are plotted in chronological order, and the standard numbers to which they correspond are shown at the bottom of the figure. . . . 38

Fig. 14. Assay precisions achieved by the SRP K-edge densitometer in 40-min densitometry assays on plutonium solutions with concentrations ranging from 5 to 200 g/L. Precisions equal to or better than 0.5% are attainable on solution concentrations from 30 to 100 g/L. However, assay accuracy begins to suffer above 70 to 100 g/L (see text and Figs. 15 and 16). Also shown is an indication of the precisions attainable with a count time half as long. Essentially the same precisions would also be obtained for a 40-min assay with transmission sources that had decayed through one half-life. . . . 40

Fig. 15. A comparison of the SRP K-edge densitometer assay results on standard solutions with the declared solutions concentrations from chemical analyses. Each data point represents the mean value of several autocycled assays on one portion of the standard in question. The error bars are the standard deviations of those mean values. . . . 42

Fig. 16. The per cent deviations of the SRP K-edge densitometry assays on solution standards from the declared chemical analysis values, as a function of solution concentration. Each data point is a weighted average of the data points in Fig. 15 for each standard. The mean deviation over the 5- to 70-g/L-concentration range is $-0.035 \pm 0.034\%$. At higher concentrations, assay accuracy begins to suffer because of small-angle scattering effects over the long sample cell transmission path length (see text). . . . 43

Fig. 17. A plot of the SRP K-edge-densitometer plutonium assay statistical precisions obtained in the presence of uranium admixtures. The results are plotted as a function of the U/Pu concentration ratio and are shown for the case of the extrapolated assay analysis. . . . 45

Fig. 18. A comparison of the SRP K-edge densitometer plutonium assays on mixed U/Pu standards with the analytical chemistry results. The assays without the extrapolation procedure described in Appendix A exhibit increasing inaccuracy for increasing U/Pu concentration ratios. The extrapolation procedure seems to remove the inaccuracies successfully. . . . 46

Fig. A-1. Schematic of the mass-absorption coefficient as a function of photon energy. Curves are shown for a sample material (assumed to be a heavy element), a heavy-element matrix component, and a light-element component. Absorption coefficient and energy labels are given to establish the notation used in the text. . . . 50

Fig. A-2. Relative statistical uncertainty in the plutonium concentration measurement by K-edge densitometry as a function of sample-cell thickness (transmission path length). Curves are shown for several plutonium concentrations and were obtained under count rate assumptions consistent with the conditions encountered at the Savannah River Plant. In particular, the empty-cell transmission count rate below the plutonium K edge was taken as 2×10^6 counts in the 121.1-keV photopeak. This corresponds to the result obtained with a 20-kc detector count rate and 1000-s spectrum count times. . . . 56

TEST AND EVALUATION OF THE IN-LINE PLUTONIUM SOLUTION
K-ABSORPTION-EDGE DENSITOMETER AT THE SAVANNAH RIVER PLANT

Phase I, Off-Line Testing Results

by

H. A. Smith, Jr., T. Marks, S. S. Johnson, L. R. Cowder,
J. K. Sprinkle, Jr., C. O. Shonrock, R. W. Slice, D. L. Garcia,
K. W. MacMurdo, R. L. Pollard, L. B. Baker, P. Christie, and J. P. Clark

ABSTRACT

An in-line, plutonium-solution, K-edge absorption densitometer has been developed at Los Alamos National Laboratory and is currently undergoing test and evaluation at the Savannah River Plant (SRP). The first phase of the test and evaluation (off-line instrument calibration and solution assays) was completed, and preparations are under way to install the instrument in-line, as soon as process schedules permit.

Calibration data in the design concentration range of 25 to 40 g Pu/L demonstrate routine achievement of densitometry assay precisions of 0.5% or better in 40 min. Plutonium assays at concentrations outside the calibration range were investigated in an effort to define better the limitations of the instrument and address other possible assay situations at SRP. Densitometry precisions obtained for 40-min assays range from 3% at 5 g Pu/L down to 0.4% at 70 g Pu/L. At higher plutonium concentrations, the precision deteriorated due to increasing gamma-ray absorption by the solution. In addition, with actinide concentrations above approximately 100 g/L, the assay accuracy also suffered because of enhanced small-angle scattering effects in the large sample cell.

Measurements on mixed U/Pu solutions demonstrated the feasibility of accurate plutonium assays with correction for the large uranium matrix contributions being determined from the measurement data.

Isotopics results on a limited set of available isotopic batches indicate that the $^{239,240}\text{Pu}$ weight fractions can be determined with relative precisions of approximately 0.4 and 3.0%, respectively. The $^{241}\text{Pu}/^{239}\text{Pu}$ and $^{238}\text{Pu}/^{239}\text{Pu}$ isotopic ratios can also be determined with precisions of approximately 1.9 and 5.1%, respectively.

In a mockup of the in-line solution plumbing system, all assay sequences, error conditions, and interlock criteria were exercised and verified to be working properly.

I. INTRODUCTION

A. Background

Increased timeliness and reliability of assays of special nuclear material (SNM), without major sacrifices in assay accuracy, are primary concerns throughout the nuclear fuel cycle. These concerns have resulted in an increased interest in the further development of nondestructive assay (NDA) techniques (as opposed to the more time-consuming and costly destructive analytical methods) as the most cost-effective way to meet these goals. However, implementation of effective NDA instrumentation in a plant environment requires significant innovative efforts in the areas of technique development, instrument portability and ruggedness, human engineering, and instrument automation. With these considerations in mind, in early 1979 a cooperative plan was developed by Los Alamos National Laboratory, the Savannah River Plant (SRP), and the US Department of Energy (DOE) for the test and evaluation of an in-line NDA instrumentation system for plutonium solutions in an operating process environment. The primary design goals were careful attention to safety, minimal disruption of process operation by the assay procedure, and ease of operation by plant personnel. In addition, the measurement design goal was the determination of the plutonium concentration to better than 0.5% (1σ) in the precipitator feed solution while it is resident in the cation-exchange concentrate holding tanks of the plutonium process line at SRP. Although the expected plutonium concentration was relatively low (approximately 30 g Pu/L), the solution would be freshly separated and essentially free of any contamination from high-Z material such as americium or uranium.

The technique of K-absorption-edge densitometry¹⁻⁴ was selected, and an instrument was developed and given preliminary tests at Los Alamos.⁵ In addition to measurement of plutonium concentration, the instrument was also equipped to provide isotopics information on the solutions assayed.

In April 1980, the instrument was shipped to SRP to begin the formal test-and-evaluation exercise. This exercise was specified to proceed in two phases. First, the instrument was installed in a designated glove box in the SRP analytical laboratory area where

- (1) initial calibration was performed,
- (2) all possible operational modes of the system and its anticipated interactions with the process were tested, and
- (3) SRP operations personnel received preliminary training in the use of the instrument.

In the second phase of the test and evaluation, the densitometer will be installed on-line, as soon as it is practical to interrupt the process to install the densitometer/process-line interface hardware.

This report provides a detailed description of the densitometer, followed by a summary of the instrument test results from all of the portions of the off-line testing phase enumerated above. We also describe tests of the densitometer's performance with sample solutions whose properties are significantly outside its design range. These latter tests were performed to document the instrument's capabilities in applications outside the scope of the intended in-line operation but relevant to locations elsewhere at SRP where measurement needs may dictate its ultimate use after the formal test and evaluation are completed.

This report serves as the primary published documentation on the SRP K-edge densitometer to date. However, an unpublished detailed operations manual has been prepared for and distributed to SRP personnel involved in the densitometer test and evaluation. Further description of the in-line operation of the instrument will be presented in a later report.

B. Basic Physics of the Measurements

1. Plutonium Densitometry. K-absorption-edge densitometry utilizes the sharp, discontinuous structure in the photon absorption probability for plutonium shown, in part, in the upper portion of Fig. 1. The sharp rise in this absorption probability at 121.8-keV photon energy is known as the plutonium K edge. By contrast, for materials other than plutonium (water is shown in the figure as an example), the photon absorption probability in this energy region is quite smooth and varies very little in the vicinity of the plutonium K edge.

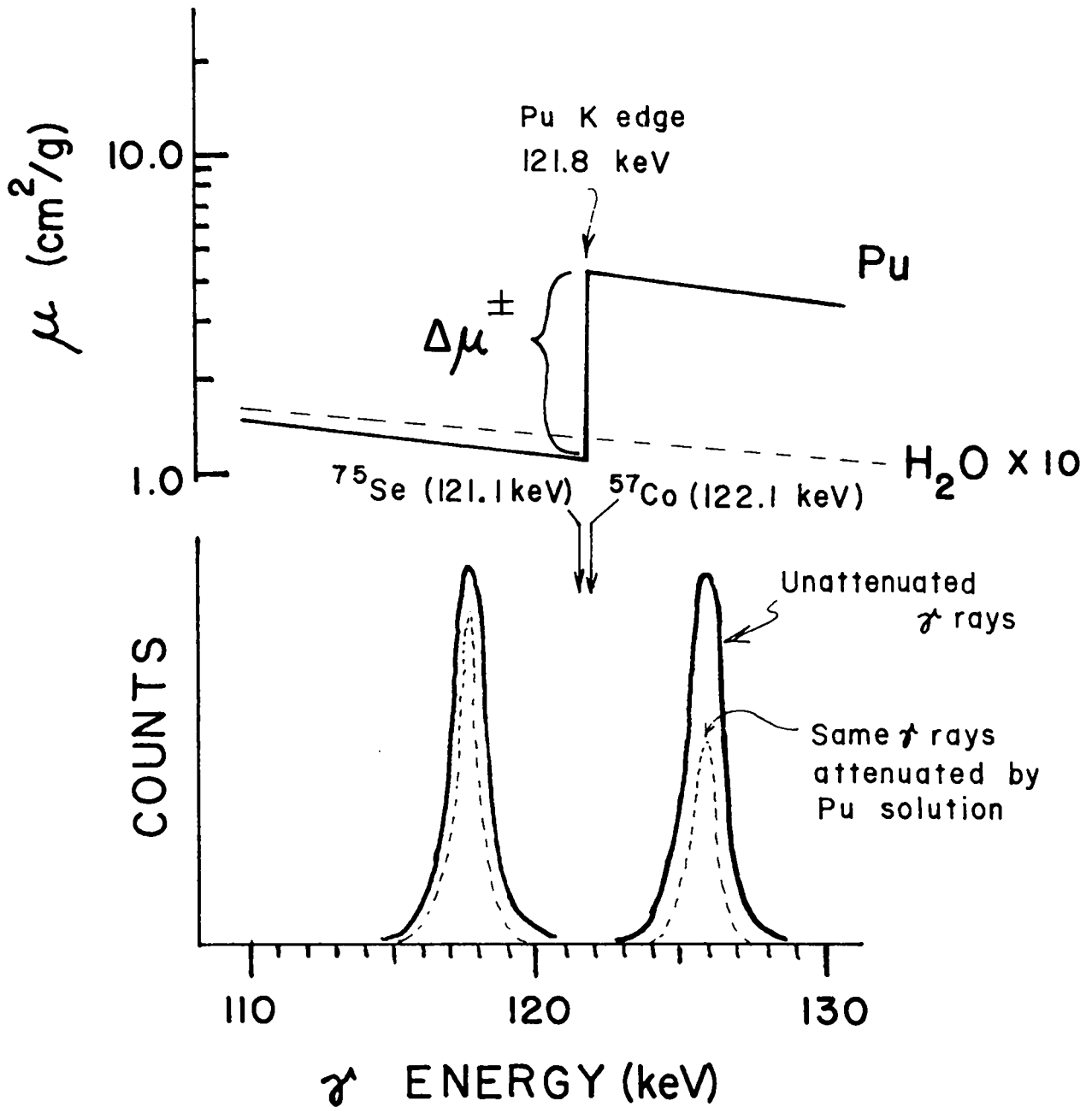

Fig. 1. Upper Portion: An expanded view of the photon absorption probability as a function of photon energy, shown in the energy region of the plutonium-K-absorption edge. Also shown for purposes of comparison is the absorption probability for water over the same energy range. Lower Portion: A schematic representation of the incident (solid curves) and transmitted (dotted curves) photon intensities for two photon photopeaks, one just above the plutonium K edge and one just below the edge. Note the dramatically higher absorption of the photon intensity above the plutonium K edge. The energy spacing of the two peaks is exaggerated for purposes of clarity. The actual energy spacing is indicated by the arrows at the top of this portion of the figure.

The experimental measurement of plutonium concentration involves the determination of the degree of absorption of two gamma rays whose energies closely bracket the plutonium K edge. The experimental arrangement is shown schematically in Fig. 2. The sample to be assayed is interposed between the source of photons and a high-resolution photon detector. In the case of plutonium assay, the two photons in question are from the radioactive source ^{75}Se (photon energy of interest = 121.1 keV; half-life of source = 118 days) and ^{57}Co (photon energy of interest = 122.1 keV; half-life = 272 days). The ratio of the photon intensity transmitted through the sample cell filled with solution to that incident upon the sample material (that is, "transmitted" with the sample cell empty) is called the transmission, T_U or T_L . The subscripts U and L refer to the photon energy just above (122.1 keV) or just below (121.1 keV) the plutonium K edge, respectively. The relative attenuation of these photon peaks upon passage through the sample material is indicated schematically in the lower portion of Fig. 1. The difference in absorption probability at the two photon energies E_U and E_L is denoted by

$$\Delta\mu = \mu^U - \mu^L, \quad (1)$$

where $\mu^{U,L}$ is the absorption probability at $E_{U,L}$. Note that this $\Delta\mu$ is somewhat smaller than the corresponding value at the plutonium K edge. This latter constant is denoted by $\Delta\mu^\pm$ in Fig. 1. For a sample transmission path length x (Fig. 2), the plutonium concentration in the sample ρ_{Pu} is given by

$$\rho_{Pu} = \ln(T_L/T_U)/(x\Delta\mu) + \rho_m\Delta\mu_m/\Delta\mu, \quad (2)$$

where $\Delta\mu_m$ is the change in absorption probability of the matrix material (of concentration ρ_m) over the same energy interval for which $\Delta\mu$ is defined. To the extent that $E_U = E_L$, $\Delta\mu_m$ is 0, and the densitometry measurement is completely insensitive to any effects from the matrix components. The close proximity of E_U and E_L in the plutonium densitometry case ($E_U - E_L = 1.0$ keV) makes

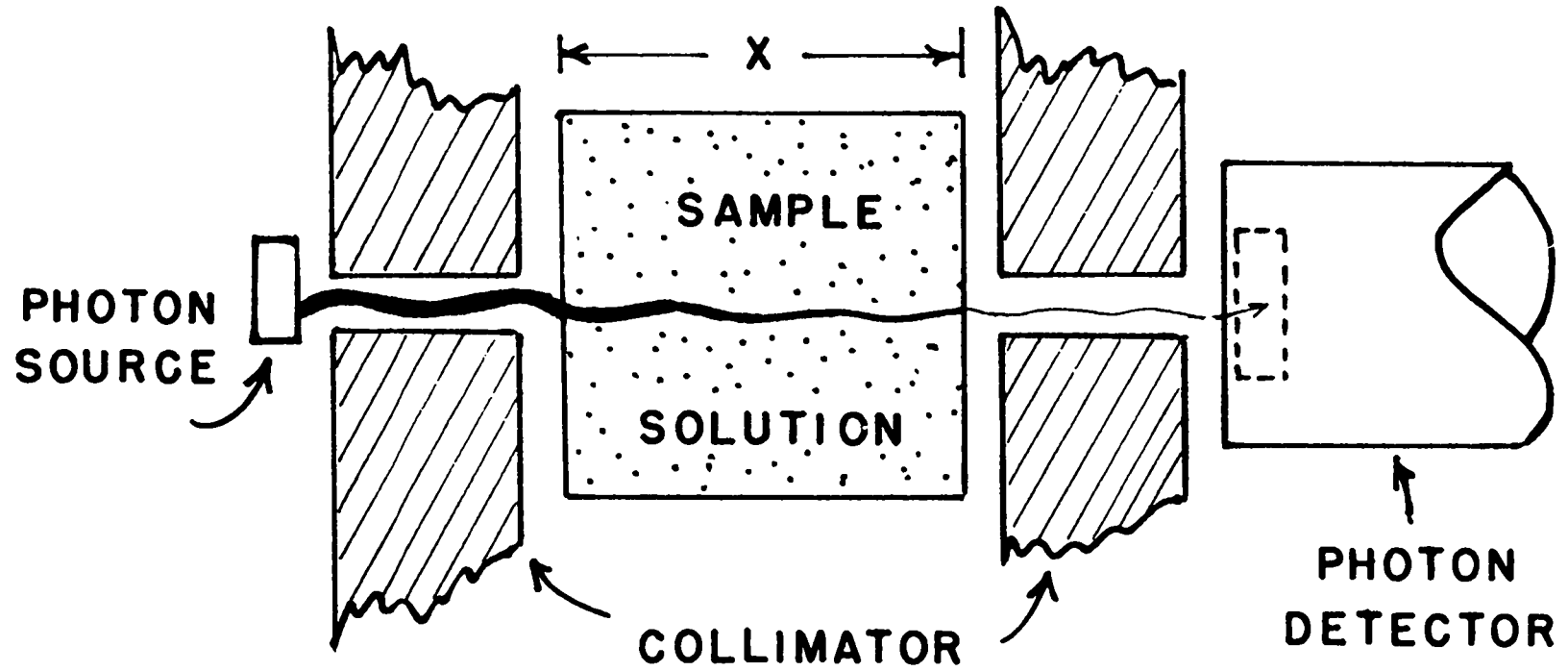

Fig. 2. A representation of a typical experimental setup for measurement of photon transmission by a sample. The photon source is collimated and the detector views transmitted gamma rays that have traversed a distance x through the sample.

the matrix contribution to the assay result very small compared with the plutonium contribution.

This matrix contribution, however, is not negligible at low plutonium concentrations, and for a 3M-nitric-acid solution is calculated to be (Appendix A)

$$\rho_m \Delta\mu_m / \Delta\mu \cong 0.15 \text{ g Pu/L (effective)} \quad . \quad (3)$$

That is, one must add a correction of 0.15 g Pu/L to the first term in Eq. (2) to remove the effect of the acid matrix. Note that this correction is independent of plutonium concentration and sample-cell geometry. For the 30 g Pu/L concentration range, this correction amounts to 0.5% of the assay result and should not be ignored. For higher plutonium concentrations, this correction becomes progressively less important. It should also be noted that variations in ρ_m (for example, fluctuations in acid molarity) are scaled down by an order of magnitude in their effect on the densitometry result in grams per liter ($\Delta\mu_m / \Delta\mu = 0.00013$); so a single additive correction, representative of typical acid molarities, is adequate in this analysis.

2. Plutonium Isotopic Analysis. The passive gamma-ray emissions by the plutonium isotopes make it possible, in principle, to assay quantitatively the isotopic composition of a plutonium solution. The most useful gamma-ray energy range for the detector used in this instrument is limited to an energy range of 80 to 200 keV by detector efficiency and window thicknesses in the instrument (see discussion of densitometer design features below). A sample gamma-ray spectrum from low-burnup plutonium in this energy region is shown in Fig. 3. With the gamma-rays available, it is possible to obtain relative weight per cent ratios for $^{238}\text{Pu}/^{239}\text{Pu}$ and $^{241}\text{Pu}/^{239}\text{Pu}$ by measurement of the following gamma-ray peaks (corrected for sample self-absorption): 153 keV/129 keV and 148 keV/129 keV, respectively. Measurement of the weight ratios for the other plutonium isotopes is not practical in this energy region, because there are no isolated gamma-ray peaks associated with $^{240,242}\text{Pu}$, and analysis of multiplets involving these isotopes results in unacceptable loss of precision or extremely long count times. As a result, the $^{240,242}\text{Pu}$ weight fractions are inferred from known correlations among the plutonium isotopes in

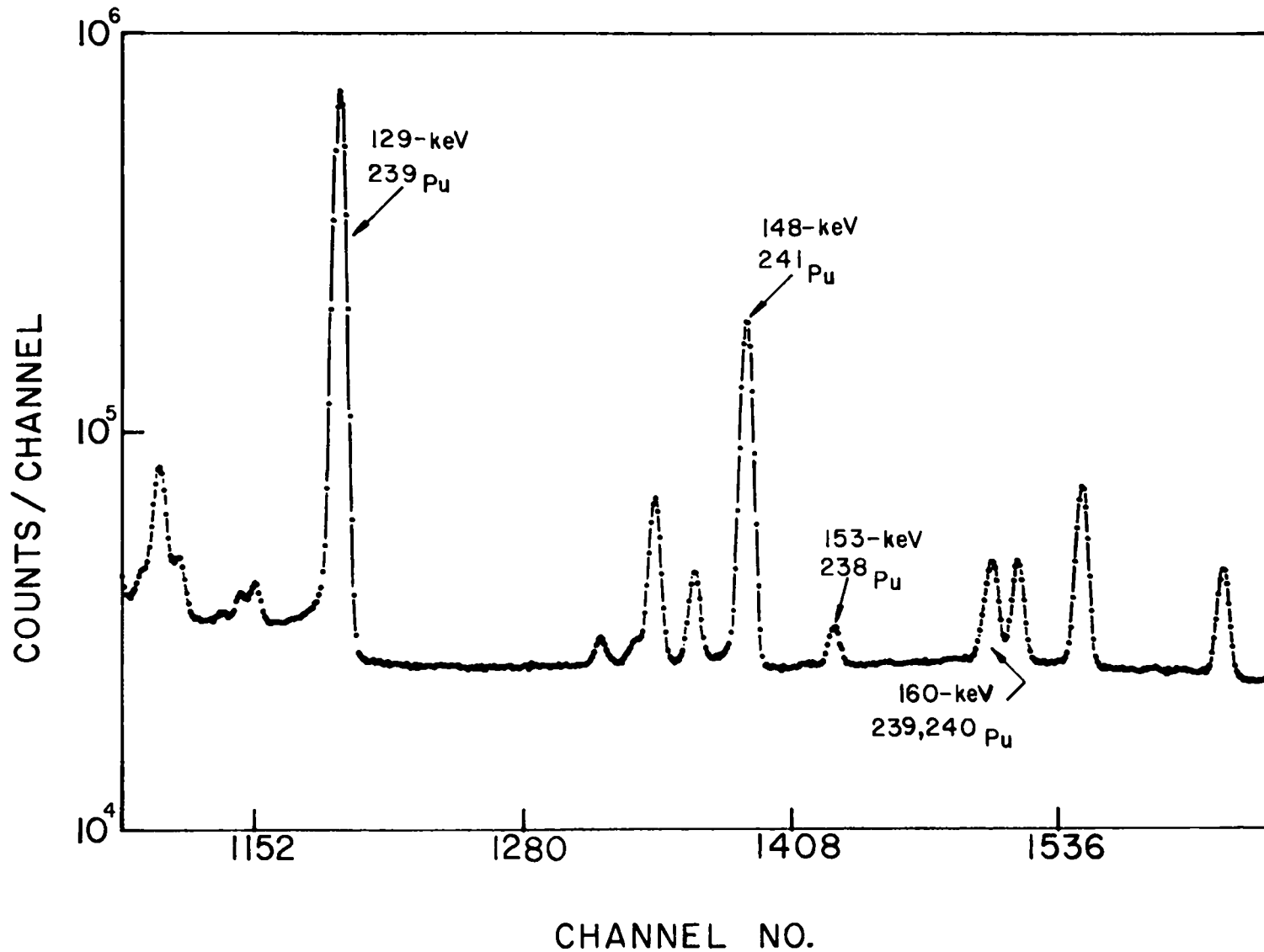

Fig. 3. The gamma-ray spectrum from a sample of low-burnup plutonium, showing the gamma-ray peaks in the energy range 120-175 keV. The isolated peaks from ^{238}Pu , ^{239}Pu , ^{241}Pu are highlighted in the figure. Also shown is a multiplet containing gamma-ray intensity from ^{240}Pu . These data are not used in the isotopic analysis because the ^{240}Pu component cannot be extracted with high precision.

reactor-produced plutonium. The total solution isotopic composition is determined by first postulating the ^{239}Pu weight fraction and using the following isotopic correlation to obtain the ^{240}Pu weight fraction

$$^{240}\text{Pu}/^{239}\text{Pu} = a_{240} (1 - b_{240}) ^{239}\text{Pu} \quad , \quad (4)$$

where A_{Pu} signifies the weight per cent of the plutonium isotope with nuclear mass number A (A = 238 to 242), relative to the total plutonium content. The constants, a_{240} and b_{240} , are derived empirically from existing isotopics data. The ^{242}Pu weight fraction is then determined using the following correlation.

$$^{242}\text{Pu}/^{240}\text{Pu} = a_{242} (^{240}\text{Pu}/^{239}\text{Pu}) - b_{242} \quad , \quad (5)$$

where a_{242} and b_{242} are also empirically derived constants.

From the measured ratios, $^{241}\text{Pu}/^{239}\text{Pu}$ and $^{238}\text{Pu}/^{239}\text{Pu}$, the inferred ratios, $^{240}\text{Pu}/^{239}\text{Pu}$ and $^{242}\text{Pu}/^{239}\text{Pu}$, and the postulated ^{239}Pu weight fraction, all of the absolute isotopic weight fractions are computed, including a recomputation of the ^{239}Pu weight fraction. The newly computed value for the ^{239}Pu fraction is then used as the postulated value, and the procedure is repeated until convergence is obtained (that is, until the sum of all the weight fractions equals 1.0 to a specified tolerance). (For further details on the isotopic analysis, see Appendix B.)

3. Heavy-Element Matrix Corrections. If the plutonium solution contains a significant concentration of heavy elements in addition to the plutonium and the acid matrix (for example, some uranium admixture), then there is an additional matrix correction required for the contribution from this added component. However, this correction can be quite large (due to the larger value of $\Delta\mu_m$ for heavy elements compared with its counterpart for acid). An alternate analysis procedure² can be used to remove the effects of the heavy-element matrix component at the cost of increased importance (that is, greater magnitude) of the acid-matrix correction. Details of this procedure and the attendant

matrix corrections are outlined in Appendix A. For plutonium assay in the presence of uranium and acid, the densitometry analysis involves the evaluation of the following expression [see Eq. (2)]:

$$\rho_{Pu} = \ln(T_L^a/T_U^b)/x\Delta\mu^\pm + c\mu_m^K \rho_m/\Delta\mu^\pm, \quad (6)$$

where $\Delta\mu^\pm$ is defined at the plutonium K edge (see Fig. 1) and μ_m^K is the acid-matrix photon-absorption probability at the plutonium K edge. The constants a, b, and c depend upon the energies E_U , E_L and the K-edge energy, as well as the energy dependence of the plutonium and acid-matrix absorption probabilities. These constants are discussed in Appendix B, and values are given there.

II. INSTRUMENT DESIGN FEATURES

A. Measurement Station

The radioactive transmission sources are mounted on a wheel that shares a common axle with a second collimator wheel, and both wheels are moved by a motorized Geneva-drive mechanism. Plutonium process solution is pumped from one of the holding tanks into a stainless steel transmission cell, which remains fixed between the transmission source wheel and the collimator wheel. A schematic of the arrangement of the wheels and radioactive sources relative to the sample chamber is shown in Fig. 4.

Each gamma-ray spectrum is measured separately by rotation of the proper source into the irradiation position. The sample cell (fixed in the measurement station) is approximately 7 cm (2.75 in.) long with a volume of approximately 90 mL. The cell has two stainless steel endfaces, each one 0.76 mm (0.03 in.) thick. The long transmission path length is dictated by the low plutonium concentrations (nominally 30 g Pu/L) intended for assay. In the in-line installation, the cell will be installed inside a small extension to the process cabinet containment as shown in Fig. 5.

In the present off-line operation, a glove-box glove port was modified to locate the off-line cell in a similar extension to the containment surface. In

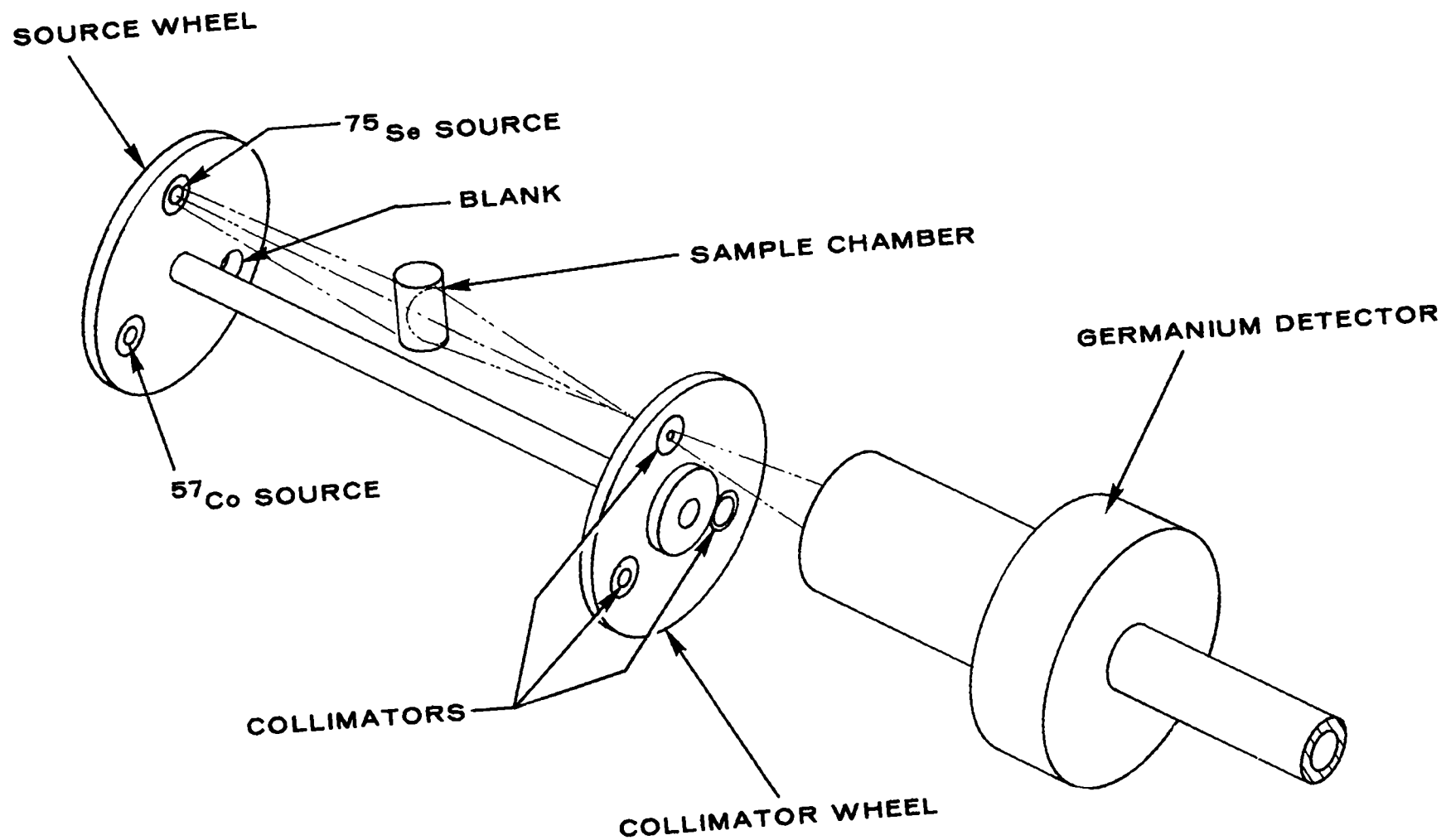
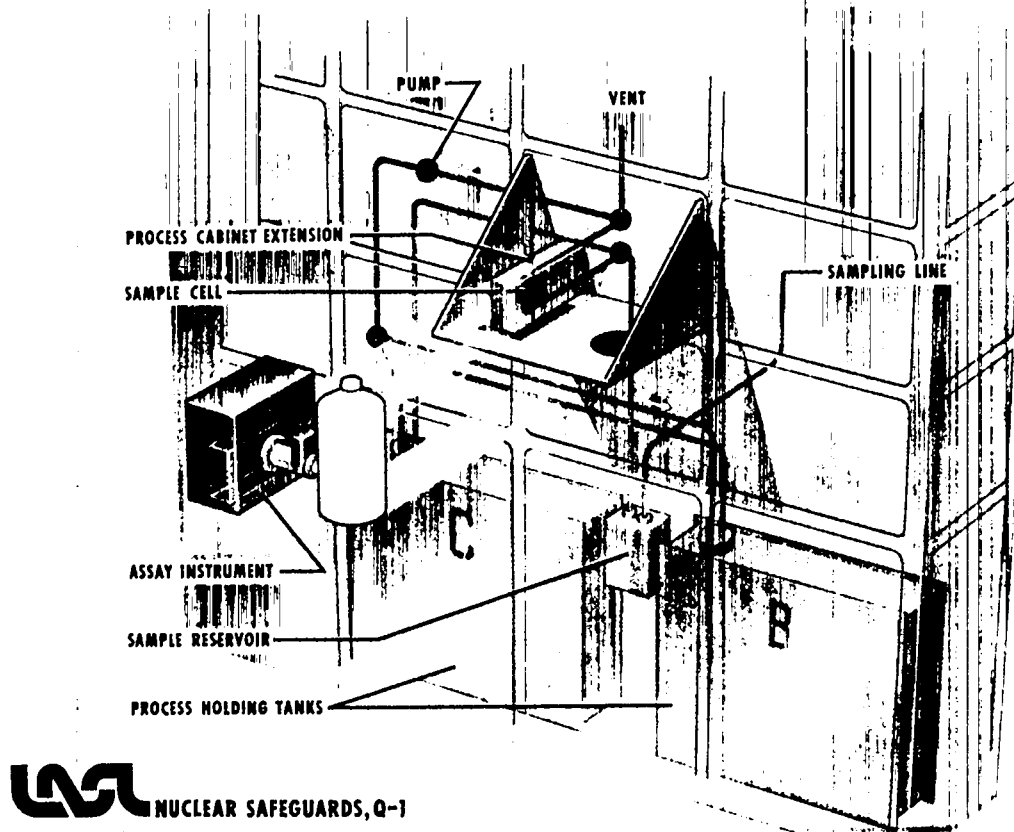

Fig. 4. Schematic of the collimator and source wheel arrangements relative to the sample cell and gamma-ray detector. Each gamma-ray spectrum is measured separately by rotation of the proper source/collimator combination into position. The tungsten collimator wheel shields the detector from the radiation from the sources that are not in use.

SRP DENSITOMETER

SCHEMATIC OF THE IN-LINE X-RAY ABSORPTION-EDGE DENSITOMETER FOR THE SAVANNAH RIVER PLANT



LSA NUCLEAR SAFEGUARDS, Q-1

Fig. 5. Schematic of the in-line installation configuration for the plutonium solution densitometer at the Savannah River Plant. A by-pass solution plumbing loop is shown, which brings plutonium-bearing solution from one of the holding tanks in the process cabinet to a measurement cell located in a small extension to the process cabinet containment. The measurement station (shown in more detail in Fig. 6) is placed over this extension so that the sample cell sits between the transmission sources and the gamma-ray detector. Provision is made in the plumbing circuit for the draining of the sample cell into an intermediate reservoir so that samples of the material just assayed can be removed for off-line assay/verification by chemical and mass-spectroscopic techniques.

both the off-line and in-line setups, the source and collimator wheels (outside the containment) straddle the extension so that the sample cell (inside the containment) sits between the transmission sources and the gamma-ray detector in a standard transmission measurement geometry. A detailed schematic of the measurement station is shown in Fig. 6, where the position of the assembly on a modified panel of the process cabinet is depicted. All instrument components except the sample cell are located outside the containment to ensure more reliable operation, ease of maintenance, and minimal contamination of the instrument. Furthermore, the use of the K-edge densitometry technique (as opposed to the L_{III} -edge technique in the 20-keV region, for example)⁶ permits the use of sturdy containment barriers between the sample cell and the instrument because of the emphasis on gamma radiation with adequate penetrability.

The measurement station hardware is surrounded on all sides by approximately 1.5 cm of lead, both to shield the operations personnel from the radiation sources inside the instrument and to shield the detector from the background radiation from the process cabinet. The gamma-ray detector itself is shielded further by 1.5 cm of tungsten for additional reduction of detected background.

Included in the measurement station is a standard plutonium foil, which can be positioned in the transmission path. Periodic assays of this foil with an empty cell serve as a convenient check of the measurement geometry and calibration.

The measurement station (Fig. 6) will be 2 m from the floor, on the operations side of the process cabinet, allowing adequate head room for operations personnel. Pulse-processing electronics and data-analysis and display equipment (described below), will be located across from the process cabinet. In the off-line mode, these latter components are located adjacent to the glove box (Fig. 7).

B. Densitometer Solution Plumbing System

The densitometer will be connected to the process by a solution plumbing system permitting solution to enter the assay cell from either of the two holding tanks or from an outside source (Fig. 8). In addition to active solution transport, the plumbing circuit provides for draining the cell contents back to the process after assay, with a diversion to an intermediate reservoir that allows sampling the assayed material for off-line chemical analysis. This

SRP DENSITOMETER

IN-LINE X-RAY ABSORPTION-EDGE DENSITOMETER FOR THE SAVANNAH RIVER PLANT

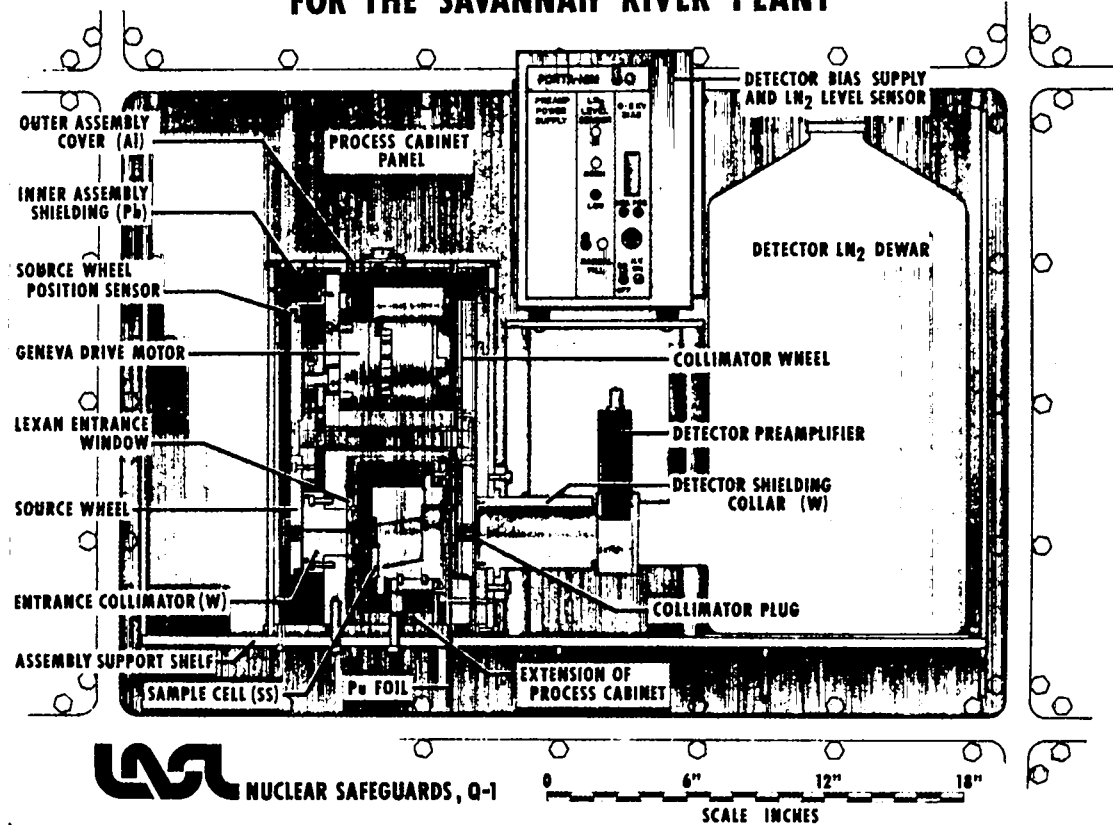

Fig. 6. Illustration of the measurement station for the in-line plutonium solution densitometer currently undergoing test and evaluation at the Savannah River Plant. The mechanism for movement of the source and collimator wheels (shown at the left) straddles the process cabinet extension so that the sample cell (inside the process cabinet containment) is between the transmission sources and the detector in the standard transmission-measurement geometry. The liquid nitrogen dewar for the gamma-ray detector is shown at the right, and the detector views the sample cell from the right, through the walls of the process cabinet extension. The entire assembly is currently installed in a plutonium solutions glove box, off-line in the SRP labs area. In the in-line configuration, this assembly will be supported approximately 2 m from floor level on a shelf attached to the process-cabinet support structure (Fig. 5).

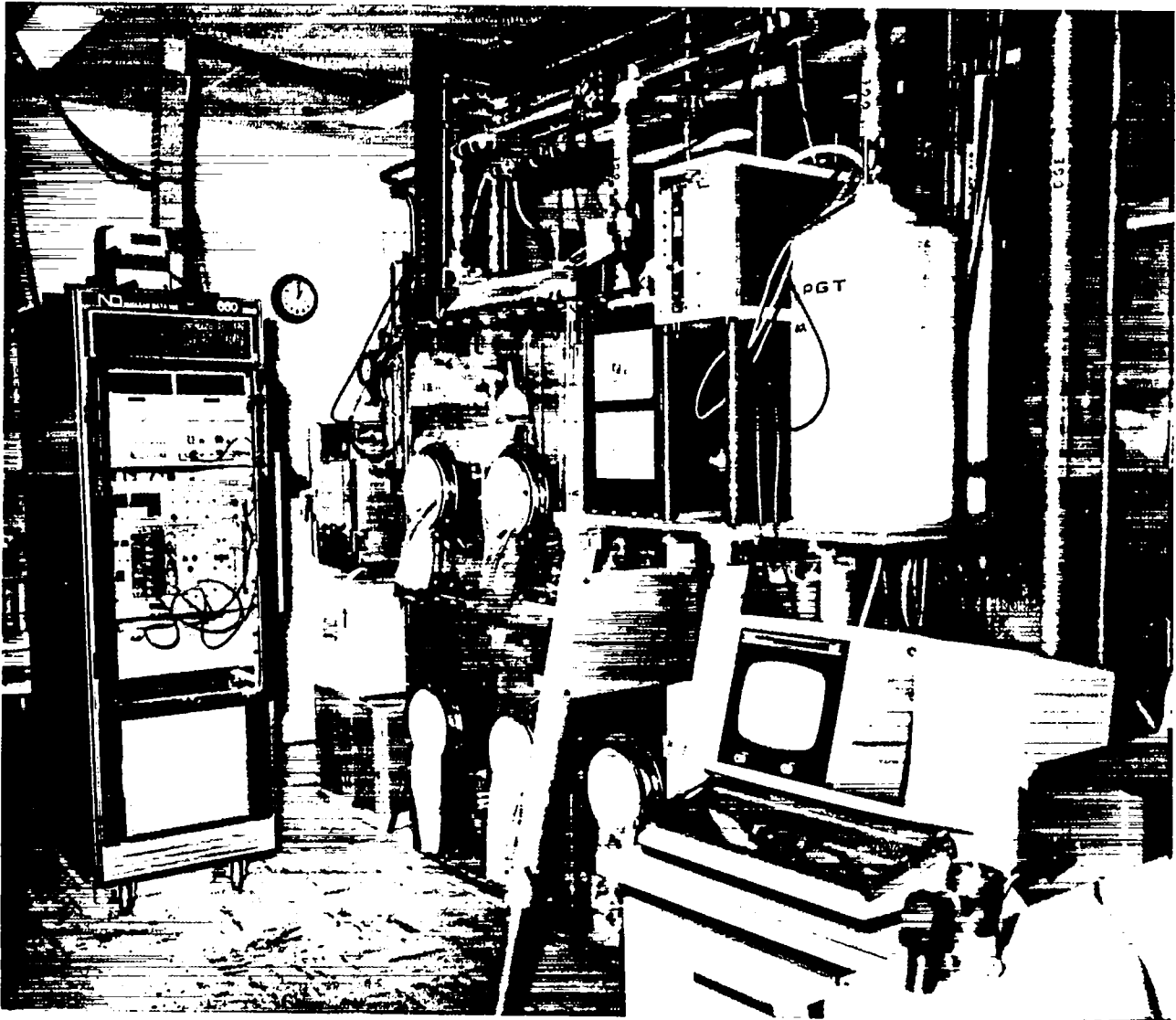

Fig. 7. Photo of the plutonium K-edge densitometer as installed at the Savannah River Plant for off-line measurements. The measurement station (see Fig. 6) is positioned over an extension of the glove box surface in a manner analogous to the intended in-line configuration. Pulse-processing and data analysis equipment are shown adjacent to the measurement station.

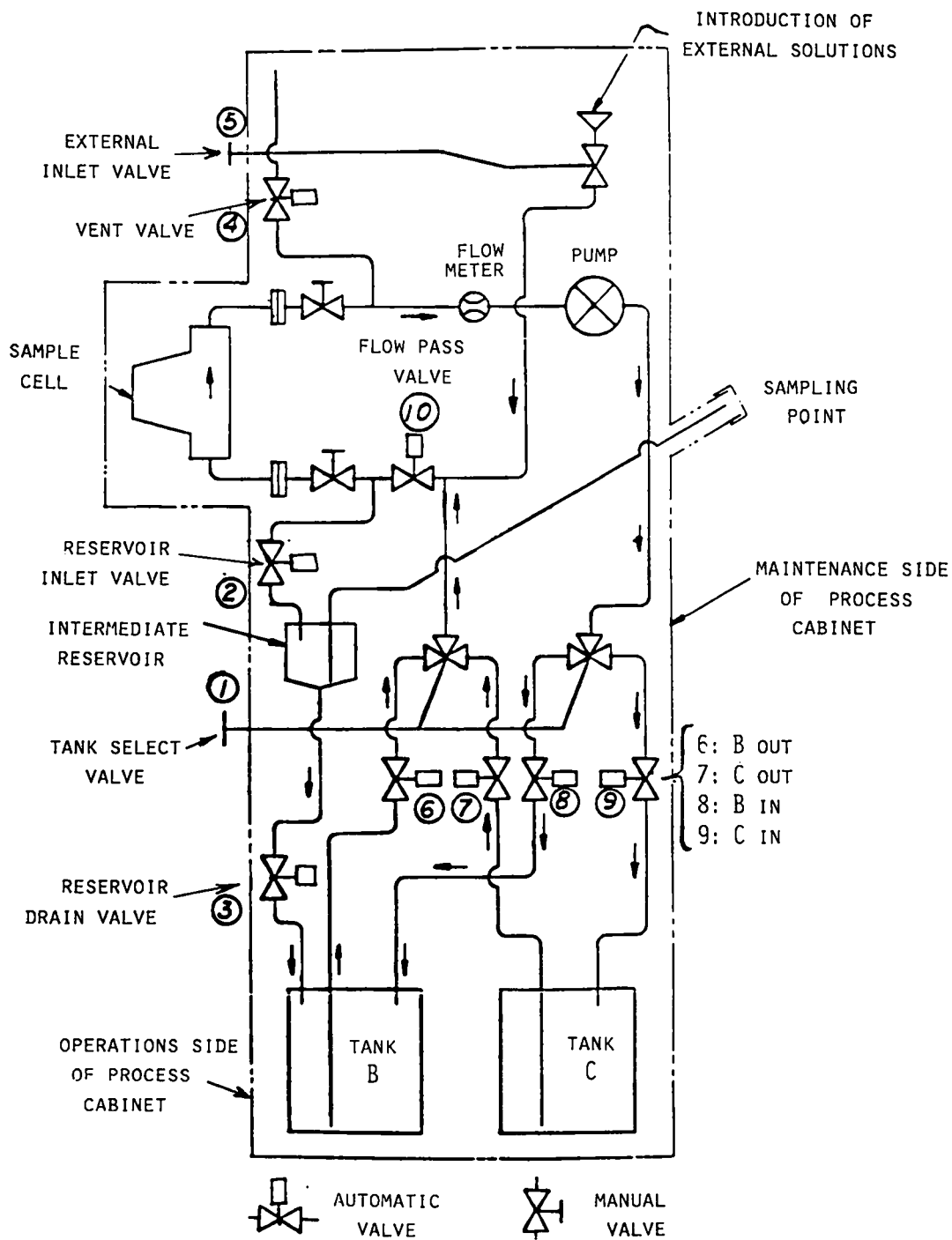

Fig. 8. Schematic of the in-line plumbing circuit for the K-edge densitometer at the Savannah River Plant. Automatic valves are activated by computer-generated commands, based upon the type of assay task requested. Manual valves are set by the operator. All valves are sensed by the computer to verify that all settings are correct for the task required. For the current set of acceptable valve settings, see Table I.

plumbing system is managed by the densitometer computer, which checks continuously for the correct valve settings and solution flow to ensure the proper transport of solution through the system without interference with the process schedule. A prototype of the in-line plumbing circuit was tested off-line under both computer and manual control, with cold solution (water only). (Details of the plumbing circuit operation are deferred until data-acquisition and analysis software are discussed.)

C. Densitometer Electronics

1. The Gamma-Ray Detector. The high-resolution gamma-ray detector used in this instrument is a 300-mm² by 5-mm-thick hyperpure germanium planar crystal, cooled to liquid-nitrogen (LN) temperature. A 1.6-mm- (1/16-in.) thick cadmium absorber is placed at the front face of the detector housing to shield the crystal from 60-keV background radiation from ²⁴¹Am. (The freshly separated sample solutions contain essentially no ²⁴¹Am.) The cadmium absorber and the thin crystal depth combine to narrow the detection efficiency in approximately the 80- to 200-keV energy range. The low detection efficiency for the higher gamma-ray energies greatly diminishes the effect on the densitometer of the hard-gamma radiation from nearby plutonium and other sources.

The detector crystal and the first (FET) amplification stage of its pre-amplifier are cooled to LN temperature to reduce thermal noise in the system. Loss of LN could cause inadvertent warm-ups of the detector and preamplifier while under high-voltage bias, so the dewar contains a LN level sensor (Fig. 6). This feature is especially important in an in-plant environment where it is impractical to burden the operations personnel with the responsibility of constantly monitoring the LN status.

A ¹⁰⁹Cd radioactive source is attached directly to the detector housing. This provides a flux of 88-keV gamma rays in an invariant geometry to correct for counting-rate losses associated with deadtime and pile-up in the system electronics.

2. Modular Pulse-Processing and Hardware Electronics. The pulses from the detector preamplifier are further shaped and amplified by a standard spectroscopy amplifier and input into the multichannel analyzer system. Periodic resetting of the dc level in the preamplifier and pulse pile-up in the detector electronics generate anomalous pulses. Logic gates, generated when the

presence of these pulses is sensed, inhibit storage. This filtering of unwanted pulses, along with optimum pulse and baseline shaping by the electronics, routinely results in a gamma-ray energy resolution of 590 eV at 122 keV at count rates of nearly 20 000 counts/s.

The pulse-height spectrum from the detector electronics is stored for analysis in a computer-based multichannel-analyzer system (MCA).^{*} The MCA conversion gain is kept constant by a two-point digital stabilizer, which is an integral part of the input stage of the analyzer. The stabilizer holds the channel locations of two gamma-ray peaks (the ^{109}Cd 88-keV peak and a higher energy peak whose identity depends upon the source being counted) constant by appropriate periodic modification of the storage address put out by the analog-to-digital conversion before storage in the analyzer memory.

The MCA is controlled by an LSI-11/2 minicomputer, which carries out data acquisition, display, and analyzer functions in the foreground mode and data analysis and densitometer control in the background mode. The computer interacts with the measurement hardware by means of commercially available electronics-interface boards and other electronics components custom-made at Los Alamos. These components allow both manual and computer-commanded operation of the solution plumbing system and the source positioning mechanism. In addition, they facilitate the read-out of: the status of all relevant plumbing valves, the position of the standard foil, the position of the transmission sources, the temperatures at key points in the instrument, and the status of fluid flow in the plumbing circuit. (More details of the computer management of the densitometer operation and data analysis are given in the next section.)

All of the pulse-processing, computer, and hardware interface electronics are housed in an air-conditioned enclosure that normally is kept locked to ensure integrity of the electronics dial settings. This environmental control should improve long-term reliability of the environmentally vulnerable instrument components and also provide added protection from contamination of the instrument electronics.

D. Computer Software

All assay sequences are fully automated and administered by the LSI-11 minicomputer. A major system engineering effort was concentrated in developing

^{*}Nuclear Data ND/660 MCA. Nuclear Data Corporation, Schaumburg, IL 60194.

computer routines. The resulting software package performs a wide variety of tasks that include:

- Operation of the mechanical measurement apparatus
- Operation of the solution plumbing system
- Operation of the MCA in accordance with data-acquisition needs
- Analysis of raw data for the resulting densitometry and isotopic information
- Imposition and/or logging of required measurement control, calibration, and sampling operations
- Performance of diagnostics tests on data quality and the correctness of the hardware operation and operator actions
- Execution of extensive operator-instrument dialogue, as needed, to aid in proceeding with an assay and to advise the operator of errors or other problem areas and suggested corrective action

The total densitometer computer program consists of 33 800 16-bit words of instructions, system library routines, and data blocks and is stored on a floppy disk in executable form. The total program is heavily overlaid to execute successfully in the computer's available 11 400-word memory space. (The analyzer foreground program and the operating system fill the rest of memory.)

1. Hardware Management. The computer software is coupled to the operated hardware through Digital Equipment Corporation (DEC) DRV-11 16-bit parallel input/output module interface boards. These boards allow the computer program both to activate powered equipment in the densitometer and to sense the status of movable devices in the instrument. Applying power to the motorized Geneva-drive mechanism in the measurement station through a "bit-on" command to a solid-state relay moves the transmission source. The source position is sent back to the computer by a dual-bit sensor that indicates which of three angular positions the source wheel occupies. The standard foil-support position is indicated in the same manner, and the computer judges whether the foil (which is moved manually) is positioned logically for the intended assay task.

Additional DRV-11 interface boards connect the assay software to the process plumbing. Two 16-bit computer words are used to activate and to sense the status of the plumbing valves, pump, and flow meter (Fig. 8). Logic-level-activated optically coupled relays, which bring ac power to the solenoid valves and pump, control the devices. Power on the automatic valves or contact

closures is sensed through optical isolators, which activate the appropriate computer bits through the DRV-11 interface boards and thereby reflect the status of the device being sensed. The optical isolators and optically coupled relays are commercially available plug-in modules, centrally located in an interface electronics cabinet near the densitometer. The plug-in feature allows convenient maintenance and reconfiguration of the interface logic. The computer software executes a number of checks to assure proper operation of all plumbing hardware. In addition, hard-wired interlocks in the interface cabinet assure a safe plumbing operation, even in the manual mode.

The wide variety of assay tasks requires a number of checks on the status of the plumbing circuit before proceeding. The valve configuration checks are based on a set of valid settings (Table I and Fig. 8) for each densitometer assay task. These "allowed" valve configurations appear in the software as a set of acceptable bit patterns (that is, data words), each bit representing the status of one device. These same computer words are used to set the valves and pump, and are compared with data words that reflect the sensed values of the valve settings. In the event of a change in the desired settings, the software is revised by changing the appropriate data words.

A discrepancy between the sensed and expected status of a valve initiates a message to the operator, sounding an alarm until the operator corrects the problem. The computer notifies the operator of incorrect manual valve settings and prompts corrective action. Incorrect automatic valve settings may mean that a valve has failed or that one of the hard-wired interlock conditions has not been satisfied (for example, the process cannot be interrupted for an assay at that time). The operator, advised of the problem and possible reasons for the error, is allowed to remedy the problem and proceed with the assay or wait until all interlock conditions are met.

Once the computer has verified valve settings, the pump is turned on and solution flows into the sample cell from the bottom. Flow sensed by the cell outlet flow meter indicates a full cell. Flow is continued for a short period to flush the system and charge the cell with the material to be assayed. Then the solution flow is stopped by closing the appropriate valves and turning off the pump, and the solution in the sample cell is ready for assay.

2. Data Acquisition and Performance Monitoring. At the beginning of the assay, the transmission sources are rotated into position for the spectrum

TABLE I

CORRECT SETTINGS OF THE TEN VALVES AND PUMP IN THE IN-PROCESS BY-PASS SOLUTION LOOP
FOR THE SRP K-EDGE DENSITOMETER, FOR THE NINE ALLOWED SOLUTION FLOW MODES

Assay Situation ^b	Valve Number ^a										Pump	
	1 ^c	2	3	4	5 ^c	6	7	8	9	10		
1. Drain cell to reservoir	CLOSED	OPEN	CLOSED	OPEN	CLOSED	CLOSED	CLOSED	CLOSED	CLOSED	CLOSED	CLOSED	OFF
2. Drain cell and reservoir	CLOSED	OPEN	OPEN	OPEN	CLOSED	CLOSED	CLOSED	CLOSED	CLOSED	CLOSED	CLOSED	OFF
3. Densitometer idle state (Also assay foil, straight-throughs)	CLOSED	CLOSED	CLOSED	CLOSED	CLOSED	CLOSED	CLOSED	CLOSED	CLOSED	CLOSED	CLOSED	OFF
4. Introduce standard solution from Tank B	CLOSED	CLOSED	CLOSED	OPEN	CLOSED	CLOSED	CLOSED	OPEN	CLOSED	OPEN	ON	
5. Assay standard solution (stopped flow)	CLOSED	CLOSED	CLOSED	OPEN	CLOSED	CLOSED	CLOSED	CLOSED	CLOSED	CLOSED	OFF	
6. Introduce solution from Tank B	CLOSED	CLOSED	CLOSED	CLOSED	OPEN	CLOSED	CLOSED	OPEN	CLOSED	OPEN	ON	
7. Assay Tank B solution	CLOSED	CLOSED	CLOSED	CLOSED	CLOSED	CLOSED	CLOSED	CLOSED	CLOSED	CLOSED	OFF	
8. Introduce solution from Tank B	CLOSED	CLOSED	CLOSED	CLOSED	CLOSED	OPEN	OPEN	CLOSED	OPEN	OPEN	ON	
9. Assay Tank C solution	CLOSED	CLOSED	CLOSED	CLOSED	CLOSED	CLOSED	CLOSED	CLOSED	CLOSED	CLOSED	OFF	

^aSee Fig. 8.

^bAssay situation numbers shown at the left are assigned in the software.

^cIndicates manual valve; all others are computer-controlled solenoid valves.

acquisition. For each source count, stabilization peaks are set, count times and spectrum windows for peak integrations are preset through communication with the foreground MCA software, and the pulse-height spectrum is then acquired in the computer memory. (Spectra are displayed on a CRT screen as they are acquired.) Counting times are preset in accordance with known source strengths and expected solution concentrations, but the times can be overridden if desired. When each count is completed, the relevant peak areas are determined by a simple region integration with linear-background subtraction. These areas (that is, photon intensities) are stored for later analysis, the spectrum is cleared from memory, and the next count begins.

During the preliminary analysis of each spectrum, certain diagnostic checks are made on the general quality of the data. Energy resolution and system gain checks are carried out by noting the widths and channel centroids of key peaks in the spectrum and comparing those results with an expected range of values. The relative intensities of certain well-known peaks are also checked to verify the stability of the relative detector efficiency and/or measurement geometry. In addition, the absolute peak areas associated with the ^{109}Cd , ^{75}Se , and ^{57}Co sources are checked against previously determined acceptable minimum values. If the count rate from any of these sources has decayed below the accepted minimum value, the operator is advised to replace the source in question to maintain good statistical precision. (The operator is also advised that, as an interim measure, the counting times should be lengthened.)

The diagnostic tests described above are performed as a routine part of every assay and measurement-control run (see II.D.4). These tests eliminate the need for the operator to monitor and judge the measurement data, and they also guide the operator toward the proper action if a problem is developing.

At the end of an assay sequence, the software has acquired a ^{75}Se and ^{57}Co spectrum, as transmitted through the sample material, and a plutonium spectrum if isotopics analysis is desired. Relevant peak areas and their uncertainties are stored and ready for analysis.

3. Data Analysis. The peak areas just measured are compared with their counterparts obtained through an earlier measurement of the same spectra with an empty sample cell. Because the transmission sources have decayed slightly since the last "empty-cell" measurement, the raw transmission data are corrected for this decay to permit direct comparison with the stored (earlier)

empty-cell results. Furthermore, to correct for rate-related losses in the electronics, all spectrum peak areas are quoted relative to the decay-corrected 88-keV peak area for the ^{109}Cd source bonded to the detector.

Photon transmissions by the sample material at 122.1 (^{57}Co) and 121.1, 136.0, and 279.4 keV (^{75}Se) are then computed, and the plutonium concentration and its statistical uncertainty are determined (Appendix A). If a plutonium spectrum has been acquired, then the isotopic composition is also determined, as described in Appendix B. Shown in Fig. 9 is an example of the summary print-out after a densitometry plus isotopics assay of a plutonium sample. All relevant information is printed in this summary: date and time of assay, sample and operator identification, pertinent temperatures, and final assay results. If any of the diagnostics checks by the computer has failed, reminders of the failed tests are printed in this summary. (These reminders continue to be repeated in subsequent assays until the tests in question are passed successfully.) Normally, very little else in addition to this summary is printed during an assay. An optional, long-form print-out can be obtained that includes relevant peak areas and their uncertainties, transmission values, diagnostic check results, temperatures, and other narrative during each stage of the assay.

4. Measurement Control. In support of the regular assay sequences, certain periodic measurements are made with the sample cell empty to maintain high quality in the measurement data, minimize systematic errors, and provide reference data for the determination of photon transmissions.

a. Instrument Calibration. This procedure is used infrequently and involves assay of well-characterized solution standards for plutonium concentration and for plutonium isotopic composition. Assay of a plutonium-free solution gives the magnitude of the acid-matrix correction [Eq. (2) and Appendix A], and measurement of well-characterized plutonium solution standards determines the primary calibration constant $\Delta\mu x$.^{*} Isotopic measurements

^{*}In principle, $\Delta\mu x$ can be calculated theoretically, because $\Delta\mu$ is a constant of Nature and x is the length of the transmission path of the sample cell. The value of $\Delta\mu$ between the gamma-ray energies of 121.1 and 122.1 keV is 3.24 cm^2/g for plutonium, and x is nominally 7 cm for the present densitometer. Thus the theoretical value for $\Delta\mu x$ is 22.68 cm^3/g , subject to the knowledge of x for the sample cells used.

```

*****
CYCLE:      56
ASSAY RESULTS:  OPERATOR:  04860           12-MAY-80  08:38:41
                SAMPLE ID: C-7(C)/DFZ/09MAY8002RUN 212
                LATEST STRAIGHT THROUGH MEASUREMENTS: 08-MAY-80  16:30:50
                FILE:      C09MAY.02
                ASSAY SOLUTION FROM TANK C-7(C)

                PU DENSITY:  35.447 +/-  0.169 GM/LITER
                FRACTIONAL UNCERTAINTY:  0.48 %

                PU ISOTOPICS:

                238      239      240      241      242
WT. PER CENT   0.01456   92.98   6.259   0.6950   0.05092
SIGMA          0.00263   0.13   0.141   0.0107   0.02037

238/239 RATIO  0.00016           241/239 RATIO  0.00747
FRAC.SIGMA(%) 18.04617           FRAC.SIGMA(%) 1.53890

                (TEMPERATURES  CELL : 27.18 C  NIMBIN: 20.99 C  LSI-11: 23.61 C  )
*****

```

Fig. 9. An example of the printed summary of the assay results for the Savannah River Plant K-edge densitometer. In this example, the plutonium concentration and the isotopic composition were requested for the solution in tank C-7(C). Furthermore, the operator (identified as 04860) requested 56 consecutive assays of the same sample and designated that the spectra from the last cycle be recorded on the floppy disk for archival data storage. The sample ID (in line 3) and the file name of the recorded data (C09MAY.02) are constructed by the software from its own knowledge of the date and time of the assay and the assay request information given by the operator. Note also that the temperatures of the sample solution (CELL), the pulse-processing electronics (NIM-BIN), and the densitometer computer (LSI-11) are provided. In addition, if any of the diagnostics checks by the computer have failed, reminders of the failed tests are printed in this summary to emphasize the possibly questionable value of the results quoted. (These reminders continue to be repeated in subsequent assays until the tests in question are passed successfully.)

determine the relative detection efficiencies to be used in the $^{241}\text{Pu}/^{239}\text{Pu}$ and the $^{238}\text{Pu}/^{239}\text{Pu}$ determinations (Appendix B). Once the calibration constants have been determined, they are entered into permanent data files on the program floppy disk and are used in all subsequent assays.

b. Measurement of Unattenuated Photon Intensities and Background. Periodic measurements are made of the unattenuated ^{75}Se and ^{57}Co spectra (that is, as transmitted through an empty cell) to correct for possible small changes in measurement geometry, detector efficiency, and for uncertainties in the transmission source half-lives used to perform decay correction. These empty-cell measurements (referred to in the software dialogue as "straight-through" measurements) therefore must be repeated periodically. The software reminds the operator to repeat these measurements every 2 days. In addition, any intentional changes in the measurement geometry (relocation, replacement, or even rebiasing of the detector, replacement of the transmission sources, etc.) require an immediate update of the empty-cell spectra, although the software cannot sense this need directly.

The operator requests the empty-cell runs at the computer terminal. Normally these measurements are run overnight, with resulting high precision, so that the unattenuated intensities used in the regular assays contribute negligibly to the statistical uncertainty of the assay result. Straight-through runs are performed with optional automatic measurement recycle. Computer diagnostics compare relevant peak areas to those tabulated in earlier runs with decay correction. Discrepancies beyond established tolerances are noted, and the operator is given the option of continuing to use the previously acquired set of peak areas or accepting the new ones. (Of course, after intentional changes in the densitometer, significant discrepancies are expected, and the new data are accepted as representative of the new instrument configuration.)

Each empty-cell measurement cycle consists of the acquisition of three spectra: ^{75}Se , ^{57}Co , and a passive count of the sample cell with no transmission source in the irradiation position. The peaks considered and their purpose(s) in the assay, are listed in Table II. The passive count provides a background measurement for the plutonium isotopics analysis, which is stored as a background, to be subtracted from the corresponding measured intensities during a passive count of plutonium solution. Significant background could arise from nearby plutonium or from residual plutonium in the cell from

TABLE II

LIST OF GAMMA-RAY PEAKS USED IN THE ASSAYS AND ISOTOPIIC ANALYSES PERFORMED BY THE SRP K-EDGE DENSITOMETER

<u>Gamma-ray Energy (keV)</u>	<u>Isotope</u>	<u>Role in the Assay</u>
88.1	^{119}Cd	Loss corrections; spectrum stabilization
122.1	^{57}Co	Transmission for densitometry
121.1	^{75}Se	Transmission for densitometry; relative efficiency check
136.1	^{75}Se	Relative efficiency check
279.4	^{75}Se	Spectrum stabilization
129.3	^{239}Pu	Peak area for isotopics
148.6	^{241}Pu	Peak area for $^{241}\text{Pu}/^{239}\text{Pu}$ determination
152.7	^{238}Pu	Peak area for $^{238}\text{Pu}/^{239}\text{Pu}$ determination

previous assays, and it is wise to remove the source of background, rather than just subtract it from subsequent spectra. If the operator takes steps to remove the background, or believes that the background has changed significantly, this portion of the empty-cell measurement can be repeated by requesting only a "background count" rather than a complete "straight-through" measurement. The results from this measurement then replace earlier counts for use in the subsequent assays.

c. Standard Foil Measurements. A standard plutonium foil 1.11 mm (1.1143 in.) thick has been sealed in the measurement station. It is mounted in a movable support and is normally stored in a shielded position out of the transmission path. The foil can be pulled down into the transmission path and assayed by the K-edge technique. Sensors on the foil support tell the computer whether or not the foil is in the measurement position. The software requires that the foil be in the measurement position if a foil assay has been requested and out of the way for all other assay options. Any movement of the foil during any measurement aborts that run.

The foil thickness was chosen to simulate a 30-g/L plutonium solution. Software tests are performed to ensure that the result from each foil count is statistically consistent (2σ limit) with a well-known average value previously determined and stored. If the particular foil result is not consistent with the average value, the operator is notified, and a reminder of this failure is printed in the assay summary until a foil test is passed successfully.

A conscientious program of regular foil measurements ensures and documents long-term stability of the instrument without the time-consuming calibration checks with solution standards. In addition, a foil measurement is a useful part of the diagnostic procedures if any gross change in the instrument configuration or electronics is suspected.

5. General Software Features and Special Operational Modes. The densitometer software possesses a number of features that provide a measure of security against both unauthorized use of the instrument and hazardous conditions from unscheduled power failures. Under normal operation, the instrument is turned on, and the densitometer program is loaded and ready to function at the operator's request. However, the terminal keyboard, where all operator-instrument dialogue occurs, is in an "idle state" and is completely unresponsive until a five-character password is typed by the operator and recognized by the computer. (The keyboard terminal does not even echo the letters typed until the proper password is given.) The computer then responds with the current date and time, and the densitometer is ready for an assay request. At the normal end of a regular assay run, the instrument automatically returns to the "idle state," awaiting the next password entry. It is also possible, in response to the request for an assay option, to send the densitometer directly into the idle state. (Note also that the idle state corresponds to the case where all valves in the plumbing system are closed, as in setting No. 3 in Table I.) The password entry feature is quite effective in preventing unauthorized activation of the instrument and possible accidental operation of the system plumbing.

Any operator must enter a proper identification number when asked for the "operator ID." The format of the operator ID for this instrument is chosen to conform to that used to identify the SRP employees, and the ID given is recorded for all assays performed by that person (Fig. 9). There is also a special, "privileged" mode of software operation known as the "Diagnostic Mode."

Entrance into this mode requires the use of a special operator ID (password). Because the K-edge densitometer is in the development stage, the diagnostic mode is provided to run the densitometer under computer control but performs a number of nonroutine manipulations of the spectra and hardware while data acquisition is proceeding. Some of the options available in the diagnostic mode are:

- Running only part of an assay cycle with complete control over all count times
- Reanalyzing archival data spectra from disk
- Changing stored parameters (calibration constants, default count times, peak regions of integration, etc.)
- Running certain calibration exercises

This mode is not used by routine operators but rather by those responsible for the maintenance of the program data files or for detailed diagnostic check-out of the instrument.

The plumbing management features of the software also include some safety measures. All of the automatic valves are wired in the fail-safe "energize-to-open" mode, so loss of ac power to the system will close the valves. In addition, the computer bit patterns for opening the valves are such that when the computer is first powered up and the densitometer program is loaded, the valves are closed. Furthermore, as the densitometer program is initialized, the plumbing system is automatically sent through a "cell-drain" cycle (setting No. 2 in Table I) before going into the idle state. This assures that the densitometer begins operation with an empty cell. In addition, all regular assays are terminated with a drain cycle for the same reason.

III. CALIBRATION AND PERFORMANCE IN DESIGN CONCENTRATION RANGE

A. Back-Up Chemical Preparation and Analysis

1. Preparation of Solution Standards. Synthetic product-line vessel materials were prepared by dissolving freshly drilled turnings from new plutonium metal in HNO_3 -HF acid mixtures. The solutions were fumed down several times with 15.7M HNO_3 to remove most of the HF. Two plutonium stock solutions were prepared from two different batches of metal turnings. All of the solution standards were prepared on a weight basis using National Bureau of Standards

(NBS)-certified mass standards for calibration checks on the balances. Replicate weighings were always made to assure reliable mass measurements. Preparation of the densitometer standards involved the dilution of weighed portions of the stock solutions to the desired acid and plutonium concentration with the appropriate acids in calibrated glassware. The dilutions were also weighed several times to determine the concentrations on a weight-and-volume basis. A total of 17 standards were prepared, and their properties are summarized in Table III. (A traceable uranyl-nitrate stock solution was used for preparing the U/Pu mixtures.)

Confirmation analyses were made by two laboratories on weighed dilutions of the various synthetic product-line standards prepared using the same weighing techniques. Standard reference material (SRM) 949e from the NBS was used to prepare a calibration standard having the same matrix as the synthetic product-line material. By calibrating the plutonium assay measurement systems with SRM-949e solution, data were generated to establish concentration values that are related to NBS standards.⁷ Along with the confirmatory measurements on the synthetic product-line standards, an equal number of concurrent measurements were made with the SRM-949e solutions to establish this traceability.

The solution standards listed in Table III were prepared from the stock solutions over a period of several months, as the need arose. As a result, corrections had to be made for the fact that radiologically generated gases and evaporation concentrate plutonium solutions at a significant rate.⁷ To maintain a high degree of reliability for the concentration values of standards prepared later, tared 4-oz bottles were filled with 100-mL aliquots of the first stock solution at the time it was prepared. These bottles were capped and sealed with Parafilm and weighed. Periodic weighings were made to determine the weight loss rate. Before preparing additional standards from the stock solution, the bottles were weighed, the weight loss was determined, and the concentrations were recalculated on the basis of the new net weights.

2. Analysis of the Process Solutions. As part of the off-line tests of the K-edge densitometer, plutonium solutions were brought from the product line for densitometry assay. At the same time, a portion of the process solution collected for assay on the K-edge densitometer was given to SRP standards lab personnel for preparation and subsequent assay to establish a reliable, independent laboratory estimate of the plutonium concentration.

TABLE III

SUMMARY OF SRP DENSITOMETER SOLUTION STANDARDS PREPARED FOR THE OFF-LINE TEST AND EVALUATION PHASE OF THE INSTRUMENT^a

Standard Number	Declared Plutonium Concentration (g/L)			U/Pu Ratio ^c	Isotopic Batch ^d
	Gravimetric ^b	SRP Coulometry	SRL Coulometry		
I	41.89 (4)	41.82 (9)	41.85 (7)	0	A
II	35.41 (4)	35.40 (11)	35.34 (18)	0	A
III	29.50 (3)	29.48 (9)	29.62 (11)	0	A
IV	15.06 (10)	15.04 (13)	15.18 (10)	0	A
V	9.98 (2)	10.03 (2)	10.09 (2)	0	A
VI	4.99 (1)	4.98 (1)	5.05 (1)	0	A
VII	204.92 (10)		210.53 (32)	0	B
VIII	99.27 (50)		100.87 (38)	0	B
IX	68.81 (34)		69.68 (17)	0	B
X	68.92 (34)		70.02 (31)	1/4	B
XI	69.37 (34)		70.91 (28)	1/1	B
XV ^d	10.03 (5)	10.28 (5)		4/1	A
XVI	9.92 (5)	9.96 (5)		2/1	A
XVII	10.25 (5)	10.11 (5)		0	A

^aStandard (1σ) errors in the weight per cents are given in parentheses as uncertainties in the last digits.

^bGravimetric values of plutonium concentration were used in the densitometer calibration. Coulometry measurements at SRP were used only as a verification of gravimetric values.

^cRatio of uranium concentration to plutonium concentration; "0" signifies pure plutonium solutions.

^dSee Table IV for isotopic composition of each standard batch.

^dThe total actinide content of Standards XII to XIV was too high for successful densitometry measurements, so these standards were not used in the test and evaluation.

Portions of the synthetic product-line and NBS-949e standard solutions were used to prepare calibration standards. The concentrations of these solutions were adjusted for changes in the solution weights due to evaporation and radiolysis, as described above. Multiple weighings and mass-calibration checks were made in preparing dilutions of the process solutions for assay by isotope

dilution mass spectrometry, coulometry, and gross alpha counting. The data collected were statistically evaluated⁷ and used to calculate uncertainty estimates for the process solutions. These values are traceable to the original standards.

B. Assay of Calibration Standards and Comparison with Chemistry

Portions of Standards I, II, and III, as described above, were assayed with the densitometer. The measurements were made with a preliminary calibration obtained during the week the instrument was installed off-line at SRP. The preliminary calibration was determined through single measurements on one portion each of Standards I and III. The complete calibration involved repeated assays of several portions of all three standards.

Assays of plutonium-free acid solutions (with matrix correction term set equal to zero) give a result that is equal in magnitude and opposite in sign to the required matrix correction in Eq. (2). The matrix correction is measured with an assumed value for $\Delta\mu x$; therefore, if $\Delta\mu x$ is revised through further calibration, the matrix correction must also be revised because it contains $\Delta\mu$. Specifically, a change in $\Delta\mu x$ by multiplication by a factor r requires that the matrix correction be multiplied by the factor $1/r$.

The calibration constants were established by extensive measurements of the plutonium-free acid solution and plutonium solution assays on Standards I through III and are given by

$$\Delta\mu x = 23.3365 \text{ cm}^3/\text{g}$$

$$\text{matrix correction} = 0.165 \pm 0.050 \text{ g Pu/L (effective) .}$$

With this calibration, the standards assay results are compared to the declared chemistry values in Fig. 10. Each data point in the figure represents the percent deviation from chemistry of the statistical average of several autocycled 40-min densitometry runs on the given standard. The error bars represent one standard deviation of the mean value of each of these autocycled measurements. A weighted average of the deviations of densitometry from chemistry for these measurements shows zero bias to within 0.036% (1σ); that is, the mean of the

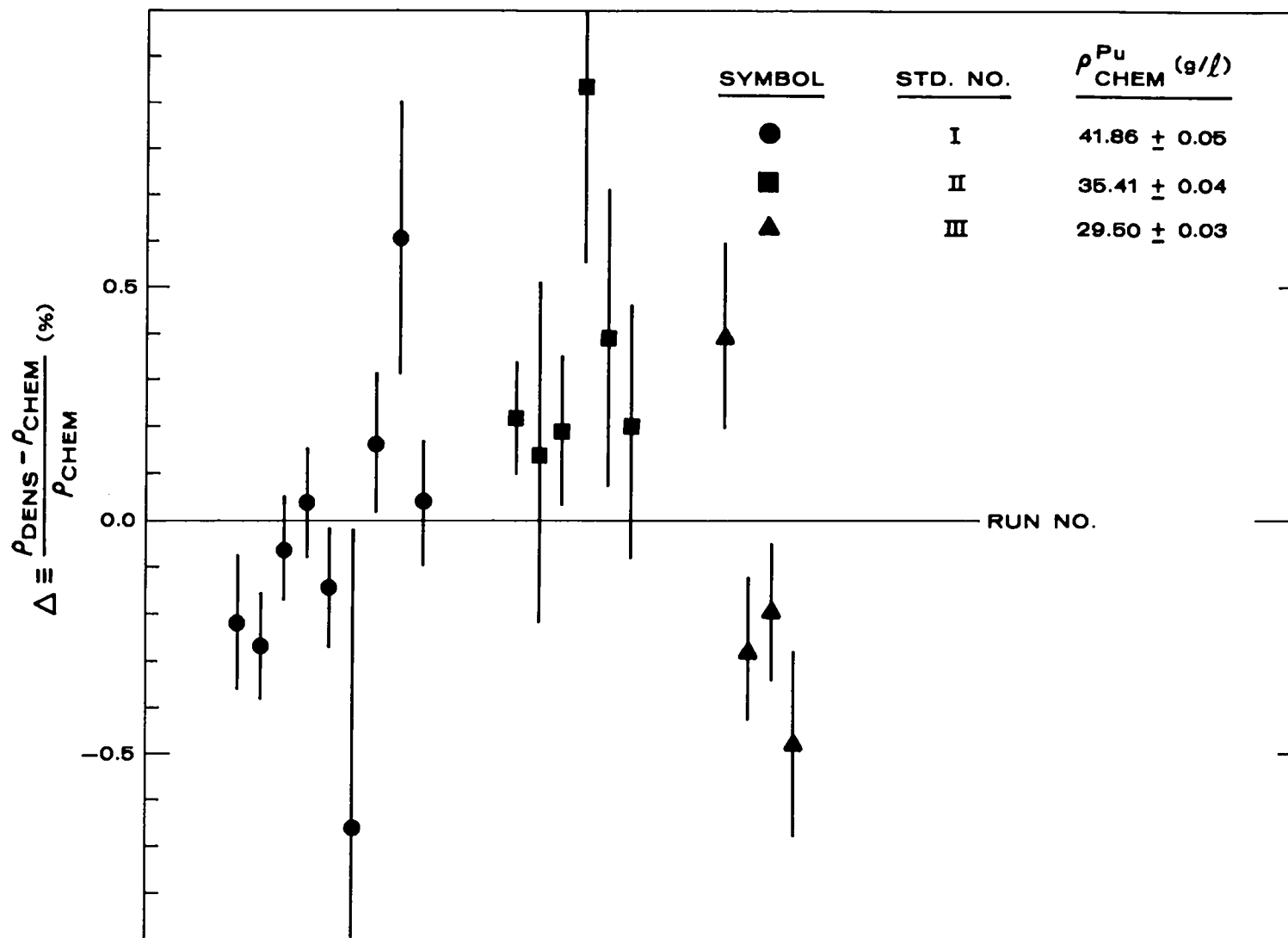

Fig. 10. Comparison of densitometry results with chemical analyses for instrument assays of Standards I, II, and III during the extended calibration exercise. Each data point stands for the average of several repeated (autocycled) assays of individual portions of each standard. The error bars represent the standard deviation of the mean of each autocycled run. The mean value of all deviations shown in the figure is $-0.026 \pm 0.036\%$.

plotted deviations was $-0.026 \pm 0.036\%$. These calibration results are tabulated and plotted further in a later section dealing with measurements of standards over a wider concentration range.

Individual densitometry precisions obtained in a 40-min assay for plutonium concentration were in the 0.4 to 0.6% (1σ) range for the concentrations measured in the calibration exercise. The precisions calculated for each run and quoted in the print-out summary (Fig. 9) were also measured by analysis of the scatter in the densitometry results from a large number of repeated (auto-cycled) assays on a single solution. These measurements showed no significant scatter beyond that predicted on the basis of counting statistics alone. Further information on instrument precision over a wider concentration range is given in a later section.

C. Measurement-Control Results

The measurement-control program during the off-line calibration exercises consisted of regular execution of the empty-cell (straight-through) runs and periodic assays of the standard plutonium foil. Straight-through spectra were acquired approximately twice per week. Over the approximately 8-month running period, the comparisons of consecutive straight-through peak intensities showed no noticeable instrument drifts. The long-term instrument stability is further demonstrated by a summary of the individual foil assays taken over the same time period (Fig. 11). The calculated individual foil assay precision was typically 0.3% for a 40-min densitometry measurement. For a given set of counting times, a foil assay gives better precision than solution assay, as a result of the lower solution assay count rates caused by the added gamma-ray attenuation from the solution matrix. The observed foil assay precision was somewhat larger than the quoted 0.3% but well within 0.5% for the 8-month period shown in the figure. This added fluctuation in the foil results is presumably due to small variations in the foil placement in the assay position, coupled with slight nonuniformities in the foil thickness.

D. Isotopics Measurements

Preliminary measurements of the $^{238}\text{Pu}/^{239}\text{Pu}$ and $^{241}\text{Pu}/^{239}\text{Pu}$ isotopic ratios during the week of off-line installation established values of the relative detection efficiencies used in Eq. (B-1) and (B-2) of Appendix B. These calibration constants are

MEASURED FOIL DENSITY (gPu/LITER EFFECTIVE)

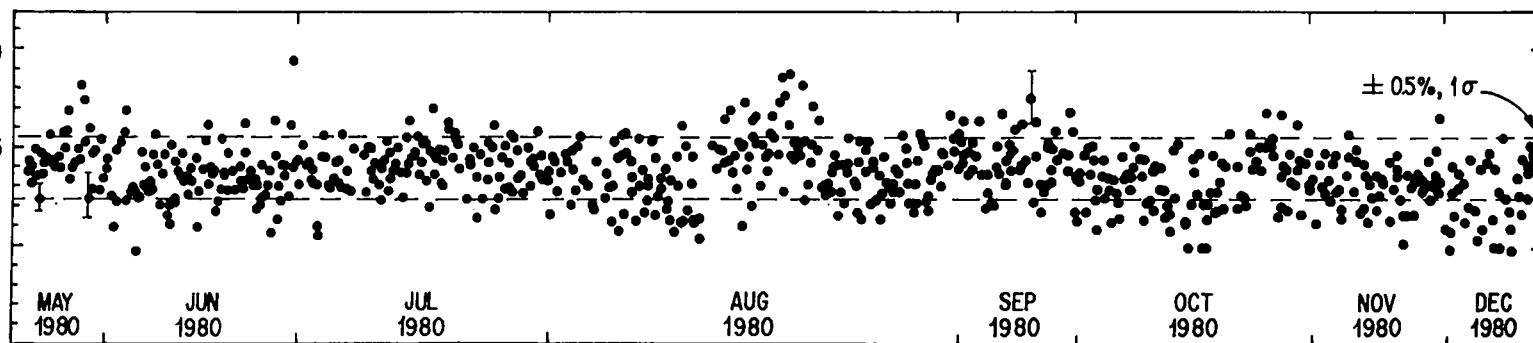

Fig. 11. A summary of all of the individual assays of the standard plutonium foil over the 8-month period from May 1980 to December 1980. The rms scatter of the assay points is within 0.5% of the average foil assay value of 29.375 g Pu/L (effective). The error bars indicate the quoted statistical precision of an individual measurement ($\pm 0.3\%$).

$$\epsilon(129/153) = 1.329 \pm 0.075$$

and

(7)

$$\epsilon(129/148) = 0.984 \pm 0.004 .$$

With these constants and the isotopic correlation coefficients given in Appendix B, the isotopic compositions of the solution standards were determined. The standard solutions were prepared from two distinct isotopic samples of plutonium metal. Table IV lists the isotopic compositions of the two types of samples assayed. These values were determined at SRP by mass spectrometry, with the ^{238}Pu fraction corrected by alpha counting. Shown in Fig. 12 are the per cent deviations of the densitometer analyses of the above two isotopic ratios, compared with SRP mass spectrometry. The results show small residual biases of $7.8 \pm 5.1\%$ in the $^{238}\text{Pu}/^{239}\text{Pu}$ ratio and $3.14 \pm 1.90\%$ in the $^{241}\text{Pu}/^{239}\text{Pu}$ ratio. These biases will be removed by appropriate adjustment of the

TABLE IV

SUMMARY OF PLUTONIUM ISOTOPICS DECLARED FOR BATCHES ANALYZED BY THE SRP K-EDGE DENSITOMETER DURING THE OFF-LINE PHASE OF THE TEST AND EVALUATION^a

<u>Standards</u>	<u>Batch a</u> <u>I to VI and XVII</u>	<u>Batch b</u> <u>VII to IX</u>
^{238}Pu	0.014 (2)	0.016 (2)
^{239}Pu	93.55 (14)	93.57 (14)
^{240}Pu	5.73 (11)	5.75 (11)
^{241}Pu	0.66 (4)	0.66 (4)
^{242}Pu	<0.05	<0.05
$^{238}\text{Pu}/^{239}\text{Pu}$	0.000150 (20)	0.000171 (20)
$^{241}\text{Pu}/^{239}\text{Pu}$	0.00706 (40)	0.00658 (40)

^aStandard (1σ) errors in the weight per cents are given in parentheses as uncertainties in the last digits.

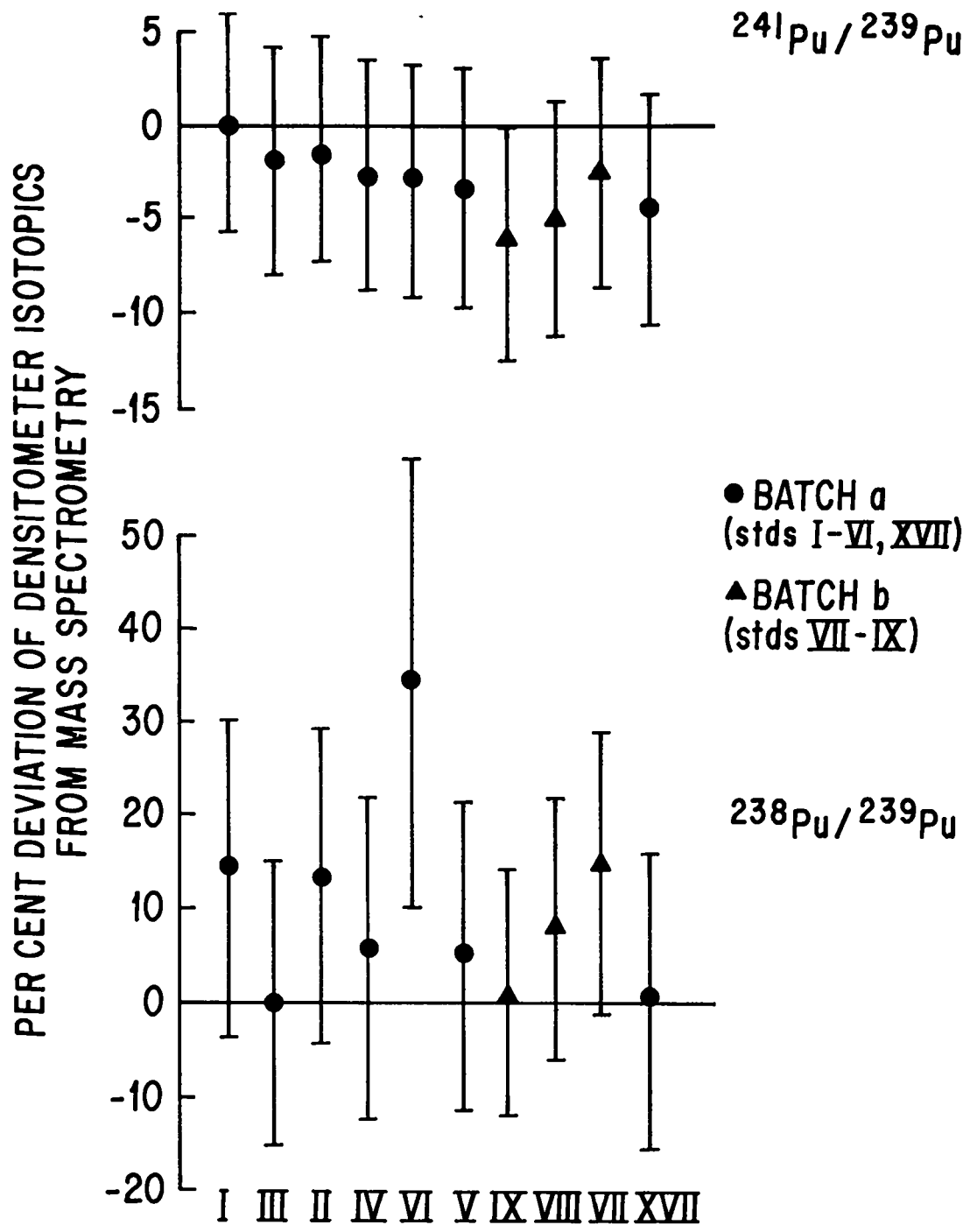

Fig. 12. A comparison of $^{238}\text{Pu}/^{239}\text{Pu}$ and $^{241}\text{Pu}/^{239}\text{Pu}$ isotopic ratios measured by the K-edge densitometer with the SRP mass spectrometry values for the two isotopic batches measured to date. These results appear to be free of any significant batch-to-batch fluctuations but show small measurement biases. Appropriate adjustment of the detection efficiency calibration constants will remove these biases. This adjustment will be performed in preparation for the in-line test and evaluation measurements. Data points are plotted in chronological order, and the standard numbers to which they correspond are shown at the bottom of the figure.

efficiency values in Eq. (7) in preparation for the coming in-line measurements. Figure 13 shows a similar comparison for the determination of the ^{239}Pu and ^{240}Pu weight fractions. Agreement between the densitometer analysis and mass spectrometry is accomplished to $\pm 0.4\%$ for ^{239}Pu and to $\pm 3.0\%$ for ^{240}Pu .

The measured isotopic ratios (Fig. 12) exhibit no noticeable batch-to-batch fluctuations, which tends to rule out any significant discrepancies between mass spectrometry and the densitometer analysis approach. On the other hand, the pronounced batch-to-batch fluctuations in the absolute weight fractions is greater than the variations within a batch (Fig. 13). This may be a reflection of the inherent precision of the isotopic correlations upon which the weight fraction analysis is based.

E. Performance of the Solution Plumbing System

A mock-up of the solution plumbing system to be used in-line was constructed for the off-line tests. All hardware components (valves, pump, flowmeter) were duplicates of the devices to be used in the process installation. The solution tubing and sample cell were transparent to facilitate full observation of the solution flow. The completed plumbing system was exercised in a cold-test mode (that is, with water) both manually and under computer control by performance of all possible assay sequences (Table I), error conditions, and interlock criteria and observation of the system response. Solution flow rates were estimated, and preliminary software delay times were set, in preparation for application in the in-line plumbing. Software and plumbing circuit performance were judged to be satisfactory, with all tests being carried out successfully.

IV. EXTENSION OF RANGE OF OPERATION

A. Introduction

In March 1980, SRP management began a process-instrumentation modernization program aimed primarily at reducing the level of process support required from the off-line chemical laboratory and, secondarily, at improving the timeliness of process control and accountability. This modernization program

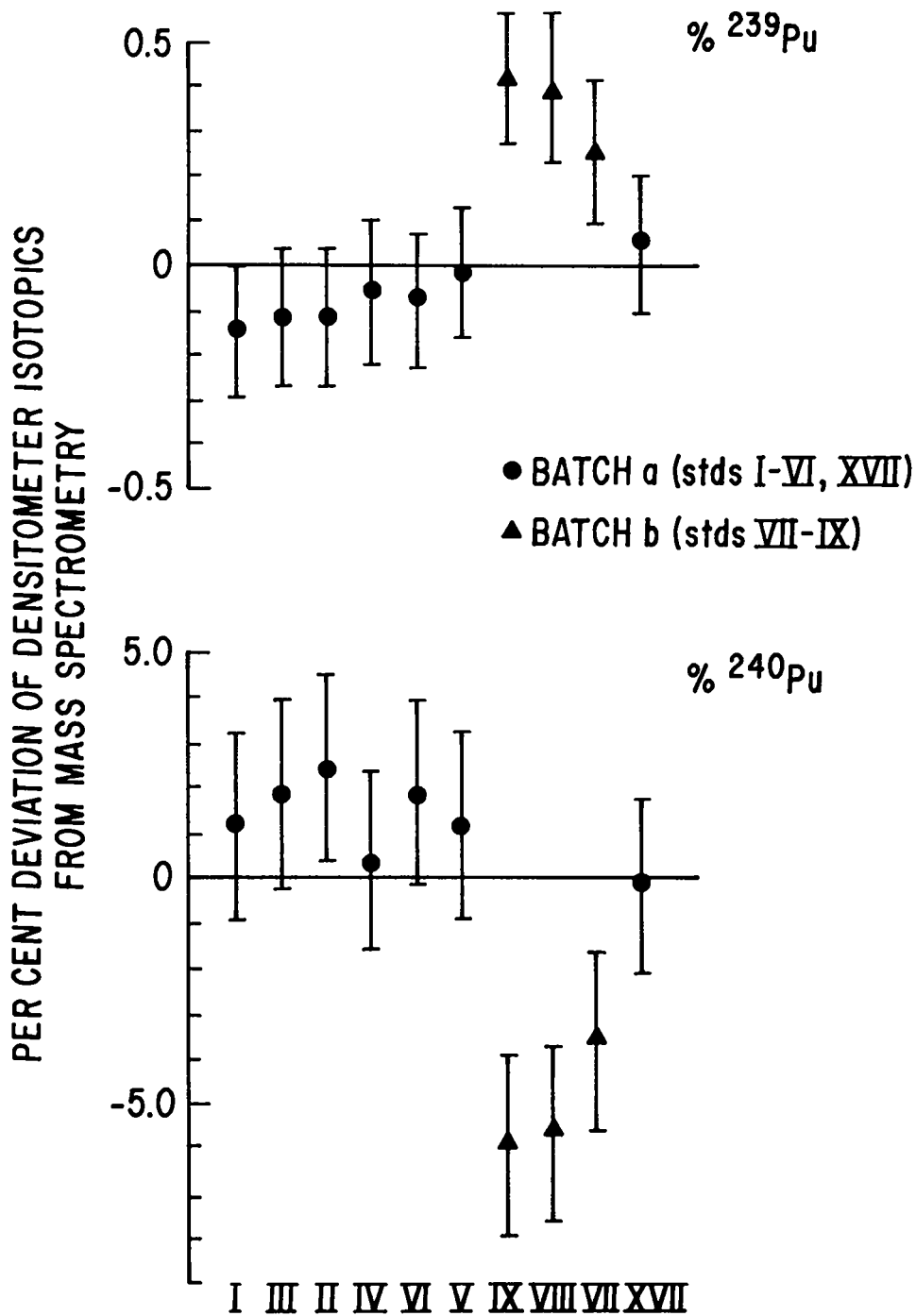

Fig. 13. A comparison of the K-edge-densitometer isotopics analysis with SRP mass spectrometry for the ^{239,240}Pu absolute-weight fractions. The batch-to-batch fluctuations in these data (in contrast to the measured isotopic ratios) are a probable indication of the inherent precisions of the isotopic correlations used in the analysis of the data. These fluctuations indicate approximate precisions for the ²³⁹Pu and the ²⁴⁰Pu determinations of the $\pm 0.4\%$ and $\pm 3.0\%$, respectively. Data points are plotted in chronological order, and the standard numbers to which they correspond are shown at the bottom of the figure.

emphasizes increased use of in-line and at-line process control, nuclear safety, and SNM-accountability instrumentation.

Because of the excellent performance of the K-edge densitometer during off-line tests begun in May of 1980 and because of the initiation of a general instrument and facility upgrade program for the SRP plutonium-product line, it was decided that the long-term value of the densitometer could be enhanced by an expanded program of off-line tests at SRP. The scope of these tests was defined to include solutions typical of additional process locations where improved instrumentation will be needed under the general upgrade program. These other process locations involve solutions with plutonium concentrations significantly higher and lower than those encountered at the cation-exchange holding tanks where the formal in-line tests will occur. These process streams also contain variable concentrations of uranium and americium and other matrix constituents (that is, nitric acid). Tests of the K-edge densitometer on these mixed solutions were used to gain guidance on refinements of the matrix-correction software algorithms and to define better the range of applicability of the instrument.

B. Extended Plutonium Concentration Range

It was of interest to learn what densitometry precisions were achievable at plutonium concentrations far above and below the 25- to 40-g/L range intended for the formal test-and-evaluation exercise. As a result, assays were performed on all of the standards listed in Table III, and concentrations from 5 to 200 g/L were represented. The precisions obtained in a 40-min densitometry assay over these concentrations are plotted in Fig. 14. It is clear that precisions equal to or better than 0.5% can be obtained on solutions with concentrations ranging from 30 to more than 100 g/L. (However, the large sample cell transmission path length undermines the assay accuracy at the higher concentrations, as discussed below.) At very high plutonium concentrations, the absorption of the transmission radiation is so strong that counting statistics deteriorate; at 200 g Pu/L, a 40-min assay gives only a 5% statistical precision. At lower concentrations, the differential absorption effect diminishes, and the transmission source count rates remain large. The assay result is therefore a small difference between two large numbers, and this also enlarges the statistical precision, so that at 5 g Pu/L, the precision has increased to 3%. For shorter total counting times, the precision also gets larger, varying

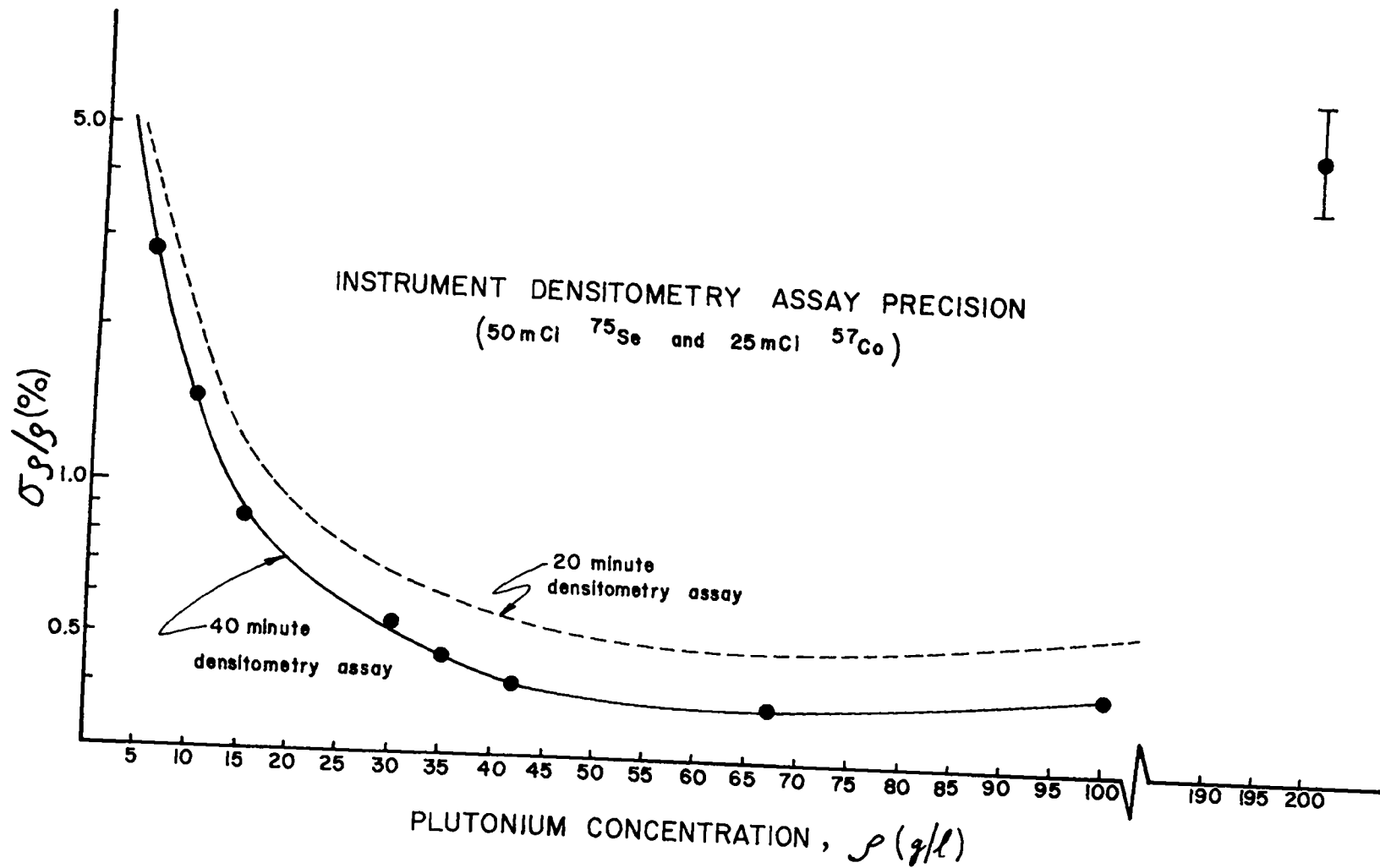

Fig. 14. Assay precisions achieved by the SRP K-edge densitometer in 40-min densitometry assays on plutonium solutions with concentrations ranging from 5 to 200 g/L. Precisions equal to or better than 0.5% are attainable on solution concentrations from 30 to 100 g/L. However, assay accuracy begins to suffer above 70 to 100 g/L (see text and Figs. 15 and 16). Also shown is an indication of the precisions attainable with a count time half as long. Essentially the same precisions would also be obtained for a 40-min assay with transmission sources that had decayed through one half-life.

approximately inversely as the square root of the total count time. A result for 20-min densitometry assays is also shown in the figure. Essentially the same precisions would also be obtained for a 40-min assay with transmission sources that had decayed through one half-life.

Figure 15 shows the comparison of the densitometer assay result with the declared values from chemical analyses for all of the standards measured. (Also repeated in this plot are the comparison data for the standards shown in Fig. 10.) The data for the low-concentration standards facilitated a small refinement of the densitometry calibration constants. With the calibration given in Sec. IV.B, assays of Standards IV (15 g/L), V (10 g/L), and VI (5 g/L) were found to be low by 0.5, 0.5, and 1.0%, respectively. This suggested that the additive acid matrix correction was low by approximately 0.05 g Pu/L (effective). Such a small bias in the matrix correction would not have been readily observable at the higher plutonium concentrations. The acid matrix correction was therefore revised upwards by 0.05 g/L. In addition, the constant, $\Delta\mu x$, was also revised upwards by 0.16% so that the calibration assays in the 25- to 40-g/L range would not be affected by the alteration of the matrix correction. The final calibration constants obtained from the off-line exercises were therefore

$$\Delta\mu x = 23.3754 \text{ cm}^3/\text{g}$$

and

$$\text{matrix correction} = 0.215 \pm 0.050 \text{ g Pu/L (effective) .}$$

In Fig. 16 we show the per cent deviations of the densitometry results from the declared chemical analysis values as a function of plutonium concentration. Each data point is a weighted average of the data points in Fig. 15 for each standard. The results show very good stability of the densitometry calibration from 5 g/L up to 70 g/L. The mean deviation over this concentration range is $-0.035 \pm 0.034\%$. At higher concentrations, a further limitation of the large sample cell begins to manifest itself. The higher plutonium concentration enhances small-angle scattering effects in the solution. The

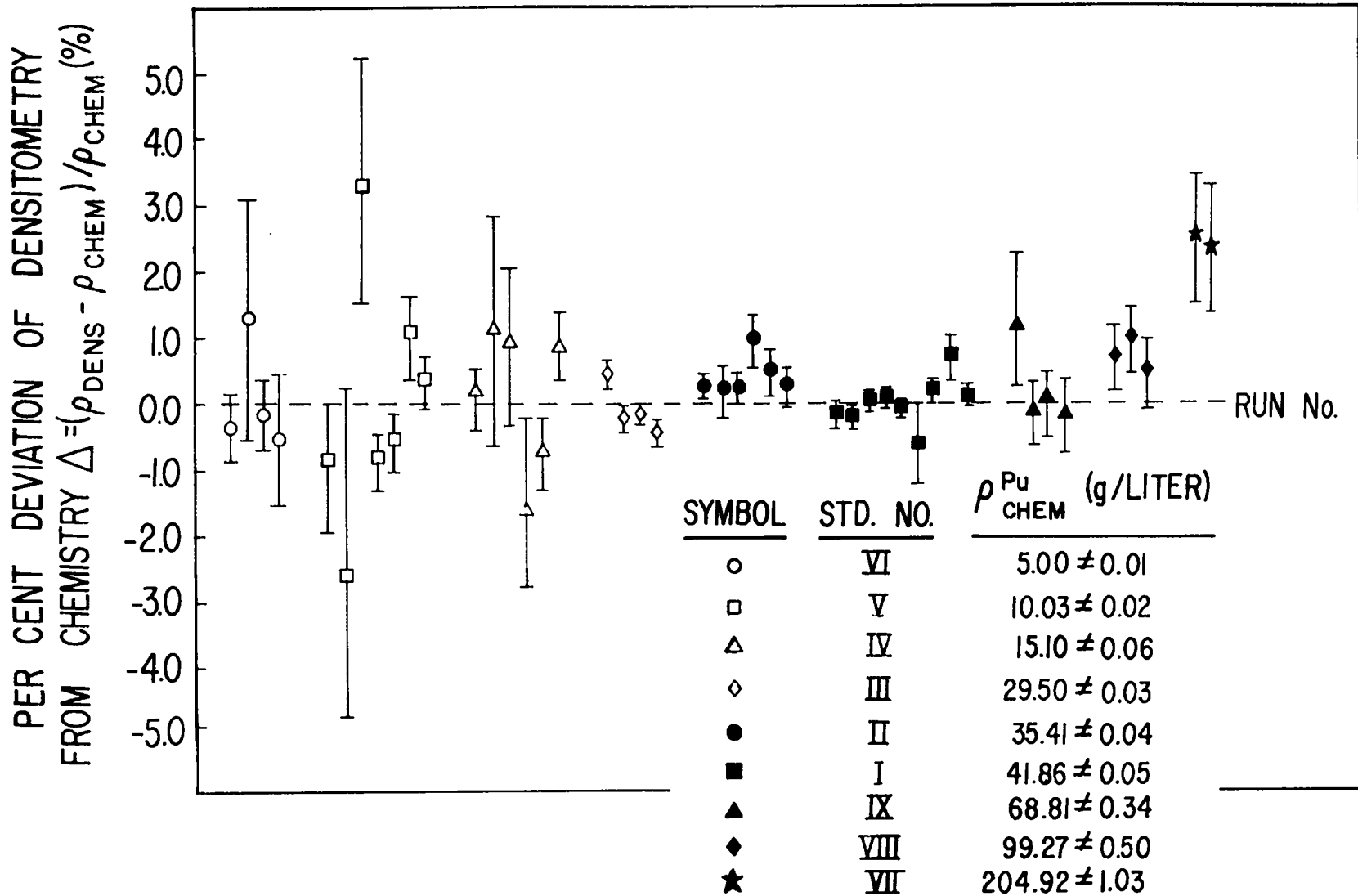

Fig. 15. A comparison of the SRP K-edge densitometer assay results on standard solutions with the declared solutions concentrations from chemical analyses. Each data point represents the mean value of several autocycled assays on one portion of the standard in question. The error bars are the standard deviations of those mean values.

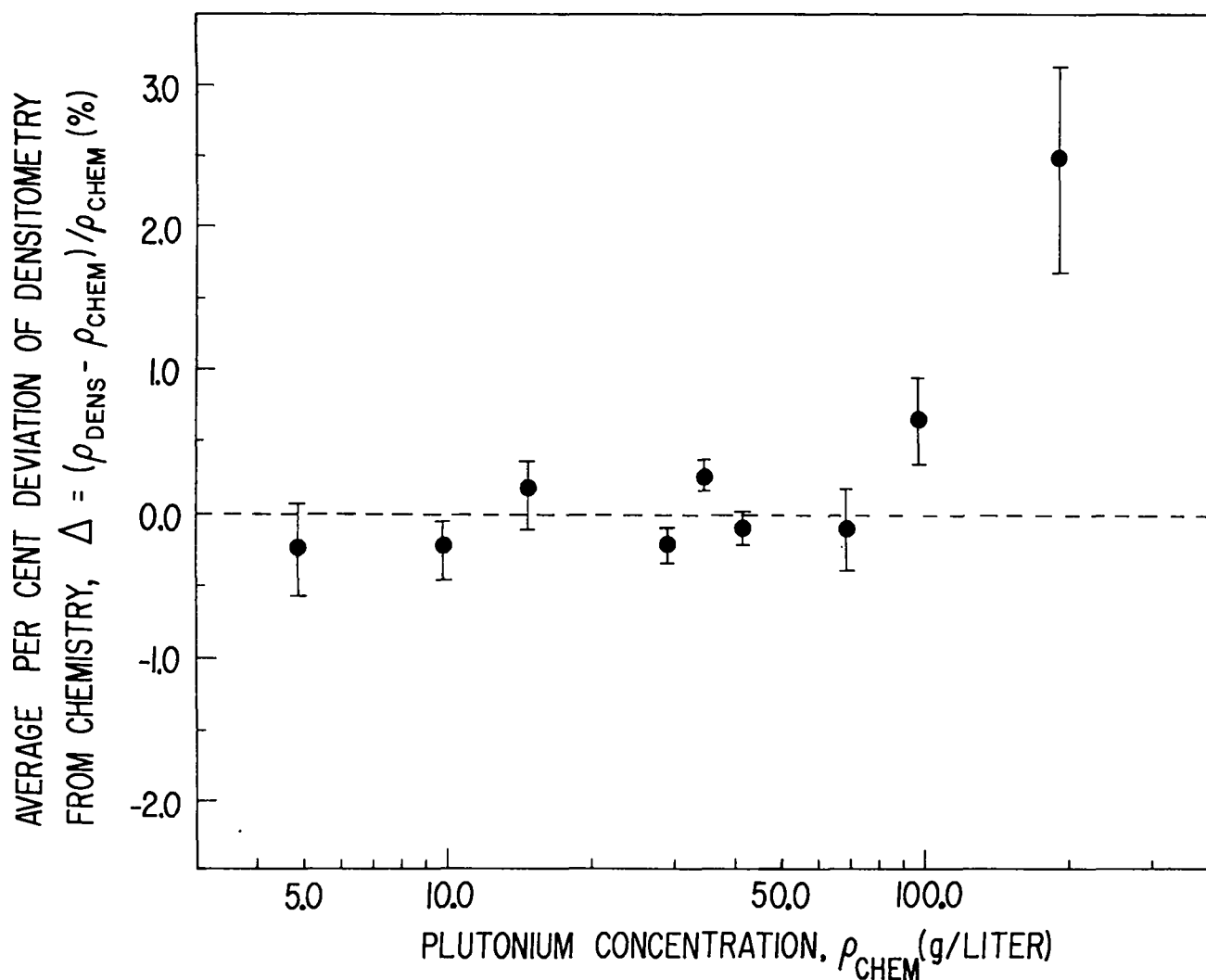

Fig. 16. The per cent deviations of the SRP K-edge densitometry assays on solution standards from the declared chemical analysis values, as a function of solution concentration. Each data point is a weighted average of the data points in Fig. 15 for each standard. The mean deviation over the 5- to 70-g/L-concentration range is $-0.035 \pm 0.034\%$. At higher concentrations, assay accuracy begins to suffer because of small-angle scattering effects over the long sample cell transmission path length (see text).

densitometry result is most severely affected by the scattering of the 122.1-keV gamma ray, because small energy losses from this gamma ray can shift its energy below the plutonium K edge. This results in anomalously low absorption of the scattered photon and a resulting excess of background counts just below its full-energy peak. Straight-line background subtraction in such a case will cause the appearance of excessive absorption of the 122.1-keV gamma ray by the solution, which translates into an anomalously large assay result. These effects (as well as the large overall attenuation of all radiation by a high-concentration solution) can be greatly minimized by the use of a smaller sample cell for assays of high-concentration solutions.

C. Plutonium Assay of Solutions with Uranium Admixtures

When the technique of differential transmission across the plutonium K-absorption edge is used for plutonium assay in the presence of varying amounts of uranium, the precision and accuracy can be seriously degraded. Both the 121.1- and the 122.1-keV gamma rays are higher in energy than the uranium 115.6-keV K-absorption edge. Thus, any added uranium is especially effective at absorbing the transmission radiation and thereby reducing the overall counting rates. In Fig. 17 we show how the densitometry precision varies with the amount of uranium admixture for two different plutonium concentrations in the 7-cm sample cell. At a U/Pu concentration ratio of 2:1 for 70-g/L-plutonium solutions, the attenuation was so severe that no peaks were observable in any of the spectra. However, higher U/Pu ratios could be assayed for plutonium with more dilute sample solutions. As a practical limit, dilute solutions with U/Pu ratios larger than approximately 10:1 probably cannot be assayed with this system due to the strong gamma-ray attenuation by the uranium. At plutonium concentrations in the 30-g/L range, this upper limit on the U/Pu ratio is probably no larger than 5:1.

In view of the large additive matrix effect from the presence of uranium in the assay samples, the plutonium densitometry accuracy is also seriously degraded [Eq. (A-2) in Appendix A]. Figure 18 compares the K-edge-densitometer plutonium assays and the chemical analyses on the mixed U/Pu Standards IX, X, XI, XV, and XVI (Table III). The figure shows that the analysis procedure used in the analysis of pure plutonium solutions (that is, without a heavy-element matrix correction) fails completely as uranium is added. On the other hand, the figure also shows that the use of the extrapolation procedure² described in

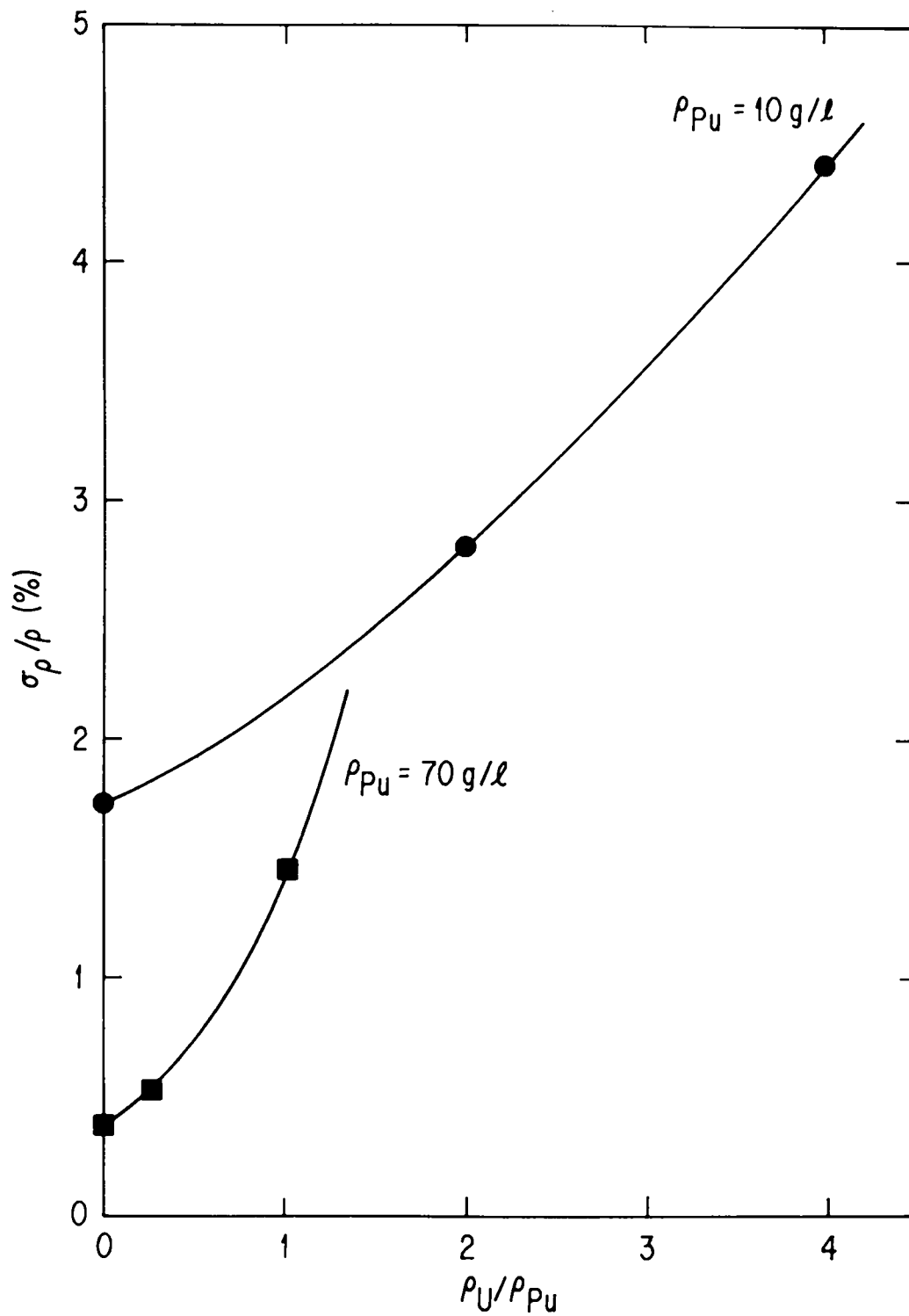

Fig. 17. A plot of the SRP K-edge-densitometer plutonium assay statistical precisions obtained in the presence of uranium admixtures. The results are plotted as a function of the U/Pu-concentration ratio and are shown for the case of the extrapolated assay analysis.

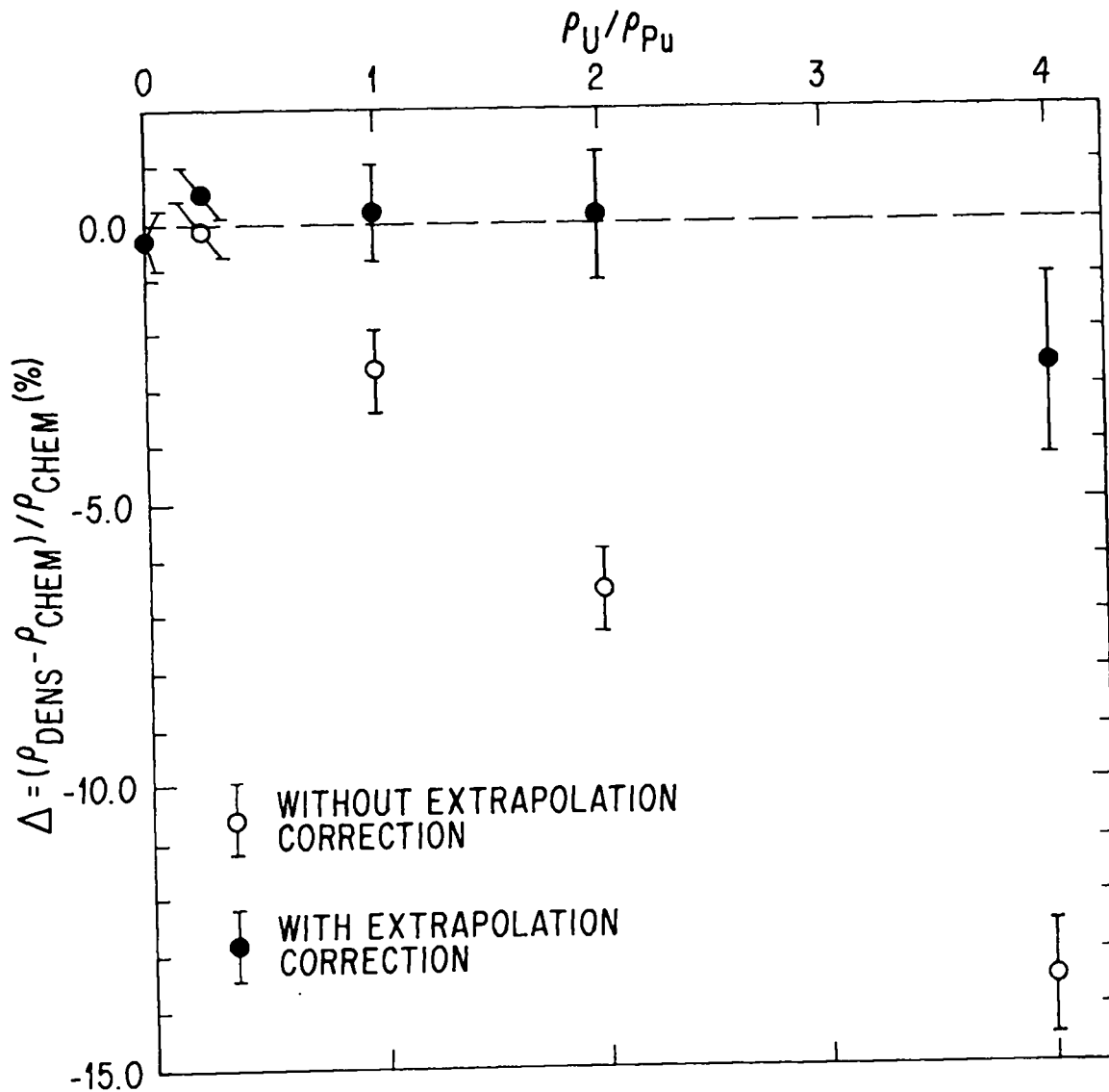

Fig. 18. A comparison of the SRP K-edge densitometer plutonium assays on mixed U/Pu standards with the analytical chemistry results. The assays without the extrapolation procedure described in Appendix A exhibit increasing inaccuracy for increasing U/Pu concentration ratios. The extrapolation procedure seems to remove the inaccuracies successfully.

Appendix A restores the plutonium-assay accuracy over a range of U/Pu concentration ratios extending through 2:1. (The small deviation of the corrected result at a U/Pu ratio of 4:1 is not understood. It may be due to difficulties in the chemical analysis for this sample or perhaps to a combination of added background from the uranium and greatly reduced statistical precision above the uranium K edge.) The parameters used in the extrapolated analysis were (Appendix A)

$$\Delta\mu^{\pm}x = 23.6449 \text{ cm}^3/\text{g} \text{ ,}$$

$$\text{matrix correction} = -0.765 \text{ g Pu/L (effective) \text{ ,}}$$

$$m = -2.55 \text{ ,}$$

and

$$m' = -0.33 \text{ .}$$

The new acid-matrix correction was obtained by comparison of assays of pure plutonium solutions with [Eq. (6)] and without [Eq. (2)] the extrapolation procedure. The constants m and $\Delta\mu^{\pm}x$ were adjusted until the inferred matrix correction was a constant, independent of plutonium concentration. In all the measurements, the acid molarity was $3.0 \pm 0.5M$, and no effort was made to explore the effects of varying the acid concentration.

The results of these measurements indicate that plutonium assays can still be performed with this instrument, even in the presence of modest amounts of uranium. The most successful results will be obtained when one controls the acid molarity and keeps the U/Pu-concentration ratio below approximately 2:1. As with the pure plutonium assays, higher U/Pu concentration ratios will require smaller sample cells and longer count times to maintain good statistical precision.

V. SUMMARY

The K-edge densitometer has demonstrated achievement of the design goal of 0.5% densitometry assay precision in a 40-min assay time, in the 25- to 40-g-Pu/L concentration range. In addition, the instrument has shown acceptable performance over a much wider concentration range, with assay precisions varying from 5% at 5 g Pu/L to 0.4% at 70 g Pu/L (for the same 40-min count time) and negligible assay bias over the same concentration range.

The isotopics performance also appears adequate, with demonstrated accuracies on solution standards consistent with quoted precisions.

Measurements of plutonium nitrate solutions with uranium admixtures showed that accurate plutonium assays are possible with solutions whose uranium concentrations are comparable to the plutonium concentration. In anticipation of possible future application of the instrument in this area, development work on this problem will continue.

The instrument electronics hardware has demonstrated good reliability over the approximately 8-month operating period, and the instrument calibration and setup have shown excellent stability during this time. The instrument/process interlocks, the solution plumbing, and its management under computer and manual control have been tested thoroughly and have been shown to operate as intended. In-line installation of the densitometer and the initiation of the second phase of the test and evaluation program should commence in the next few months, subject to process schedules. In the meantime, further assays of process solutions and tests of the instrument with uranium- and americium-matrix admixtures will be carried out off-line.

ACKNOWLEDGMENTS

The authors wish to express their appreciation to the US Department of Energy, Savannah River Operations Office, for their support of this test and evaluation exercise, and to the SRP Separations Technology Group, Laboratories Department, and other support staff for their continued cooperation throughout this project. We wish to express special thanks to Noel McGahee for his invaluable assistance with the plutonium solutions during the off-line phase of the test and evaluation of the densitometer.

APPENDIX A

FORMULATION OF THE K-EDGE PLUTONIUM DENSITOMETRY ASSAY

I. SOLUTION DENSITOMETRY

The assay of solutions for plutonium concentration using the technique of K-absorption-edge densitometry involves the measurement of the transmission (through the solution) of two photons whose energies closely bracket the plutonium K edge. In the present case, these photon energies are $E_U = 122.1$ keV (from ^{57}Co) and $E_L = 121.1$ keV (from ^{75}Se). The subscript U (L) refers to the energy just above (below) the plutonium K-edge energy of 121.8 keV (Fig. 1 in main text). Figure A-1 is a schematic of the photon absorption probability for several types of material as a function of photon energy. The sample material in this case is plutonium, and the high-Z (heavy-element) matrix component will be associated with uranium, in anticipation of the discussion to follow. The low-Z (light-element) matrix component will be associated with the acid medium in which the heavy elements are dissolved. The transmission of the photons at these two energies through a thickness x of sample solution (Fig. 2 in main text) is

$$- \ln T_U = \mu_S^U \rho_S x + \mu_M^U \rho_M x + \mu_m^U \rho_m x$$

and

$$- \ln T_L = \mu_S^L \rho_S x + \mu_M^L \rho_M x + \mu_m^L \rho_m x .$$

(A-1)

Solving for ρ_S , the plutonium solution concentration, we have

$$\rho_S = \frac{\ln(T_L/T_U)}{(\Delta\mu)x} + (\Delta\mu_M/\Delta\mu)\rho_M + (\Delta\mu_m/\Delta\mu)\rho_m ,$$

(A-2)

where the following positive differences are defined

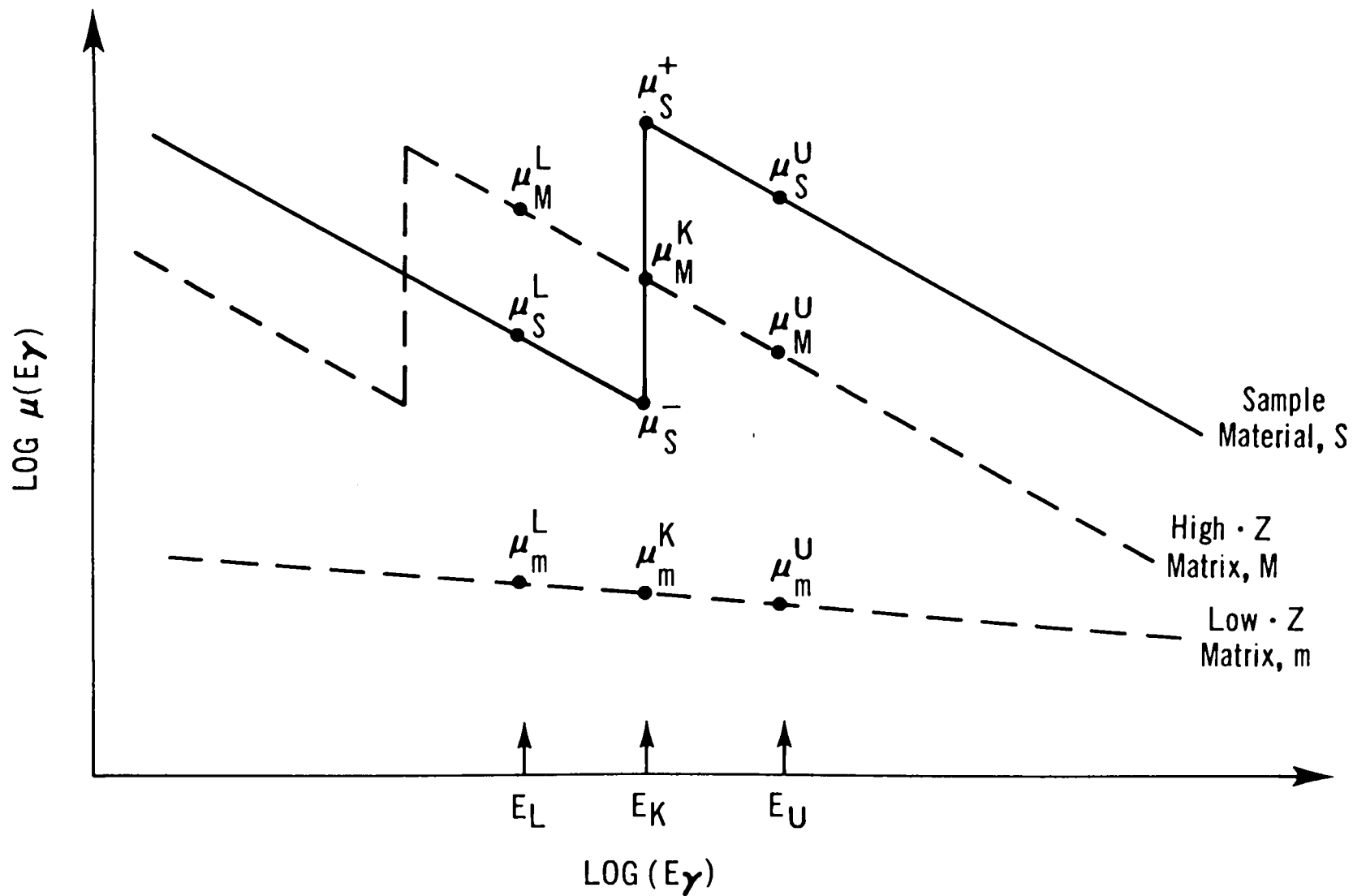

Fig. A-1. Schematic of the mass-absorption coefficient as a function of photon energy. Curves are shown for a sample material (assumed to be a heavy element), a heavy-element matrix component, and a light-element component. Absorption coefficient and energy labels are given to establish the notation used in the text.

$$\Delta\mu = \mu_S^U - \mu_S^L$$

and

(A-3)

$$\Delta\mu_{M,m} = \mu_{M,m}^L - \mu_{M,m}^U .$$

Because the transmission measurements are related to data taken with an empty cell, the quantities T_U and T_L contain contributions from the acid and heavy-element matrix components. The second and third terms in Eq. (A-2) are included to cancel this added effect, leaving only the contribution to the result from the plutonium. Note further that these matrix terms are independent of plutonium concentration and sample-cell geometry. Thus, these corrections can be applied to any K-edge densitometry measurement system for which the solution transmissions are measured relative to an empty cell.

Ideally, if $E_U = E_L = E_K$, then $\Delta\mu_M$ and $\Delta\mu_m$ equal 0, and the measurement is completely insensitive to any effects from the matrix components. The close proximity of E_U and E_L in the plutonium densitometry case makes the matrix effects small compared with the assay signal from the plutonium K-edge discontinuity. However, the "apparent plutonium assay" resulting from the differential absorption of the matrix materials is not completely negligible and must be included among the corrections to the raw transmission results.

Case a: Pure plutonium and acid matrix ($\rho_M = 0$). In this case, the plutonium concentration is given by Eq. (2) in the main text,

$$\rho_{Pu} = \ln(T_L/T_U)/(x\Delta\mu) + \rho_m\Delta\mu_m/\Delta\mu . \quad (2)$$

The acid molarity (M) and the acid density (ρ_m) are related approximately by⁸

$$\rho_m = 1 + 0.03M , \quad (A-4)$$

and the $\Delta\mu_m$ for 3M nitric acid is determined to be⁹ 0.00045 cm²/g. For a $\Delta\mu$ of 3.24 cm²/g for plutonium,⁹ the magnitude of the matrix term in Eq. (2) is 0.153 g Pu/L (effective). Fluctuations in the acid molarity have a greatly reduced effect on this matrix term [Eq. (A-4)], so a single evaluation of the matrix term at a typical acid molarity is sufficient in the present case. Because light-element components other than nitric acid may be in the matrix, it is advisable to measure the magnitude of this matrix term with plutonium-free sample material during the calibration procedure rather than use a calculated value.

Case b: Plutonium + acid and heavy-element matrix. This case differs from Case a only in the addition of the heavy-element matrix term to Eq. (2). For uranium, $\Delta\mu_M$ has the value⁹ 0.094 cm²/g, giving the matrix term the value 0.029 ρ_M . Thus, the heavy-element matrix term is a positive correction to the plutonium assay result equal to approximately 3% of the uranium concentration. Thus, high-precision plutonium assays with the straightforward matrix correction outlined above require careful determination of the U/Pu ratio.

Case c: Alternate analysis procedure for plutonium + acid + heavy-element assay samples. As mentioned above, if $E_U = E_L$, the assay result is independent of matrix composition. We can create this favorable situation by modifying the measured transmissions at E_U and E_L to the values they would assume at the plutonium K-edge energy E_K . This modification is straightforward because of our knowledge of the energy dependence of the mass absorption coefficient μ of the matrix materials. As is implied schematically in Fig. A-1, the relationship is essentially linear when expressed as

$$\log[\mu(E_\gamma)] = m \log(E_\gamma) + B \quad . \quad (A-5)$$

The important quantity in this equation is m , which for uranium and 3M HNO₃ has values -2.55 and -0.33, respectively,⁹ where E_γ is expressed in keV and μ in cm²/g. Using this energy dependence, we can express an absorption coefficient at the K edge (μ_K) in terms of its values $\mu_{U,L}$ at $E_{U,L}$ according to

$$\mu_K^L = (E_K/E_U)^m \mu^L$$

and (A-6)

$$\mu_K^U = (E_K/E_U)^m \mu^U .$$

With these transformations, we can adapt Eqs. (A-1) to the form they would assume if the transmissions had been measured infinitesimally close in energy to the plutonium K edge. Fortunately, the value of m is essentially the same for all elements with atomic numbers greater than 50,² so the uranium and plutonium absorption coefficients can be transformed with the same m (-2.55). As a result, the transformed $\Delta\mu_M$ vanishes, and the assay result becomes that given in Eq. (6)

$$\rho_{Pu} = \ln(T_L^a/T_U^b)/x\Delta\mu^\pm + c\mu_m^K \rho_m/\Delta\mu^\pm , \quad (6)$$

where $\Delta\mu^\pm (= \mu_-^+ - \mu_S^-)$ is now defined across the plutonium K edge, rather than between the energies E_U and E_L . The constants a , b , and c are defined as

$$a = (E_K/E_L)^m = 0.9855 ,$$

$$b = (E_K/E_U)^m = 1.0064 , \quad (A-7)$$

and

$$c = (E_K/E_L)^{m-m'} - (E_K/E_L) = -0.0182 ,$$

where $m = -2.55$ and $m' = -0.33$ (the average value of m for elements with atomic numbers less than 10).

Equation (6) provides a result for the plutonium concentration that is independent of the heavy-element matrix effects, but still depends upon the

light-element matrix. It is not possible to remove the effects of both the light- and heavy-element matrix materials in this way, because each type of material exhibits a different energy dependence in its mass absorption coefficient. In fact, by correcting the transmission data for the heavy-element contributions, we have actually over-corrected the effect of the light-element matrix, with the result that the second term in Eq. (6) is larger in magnitude and opposite in sign to its counterpart in Eq. (2). The approximate value of this matrix term can be determined using ${}^9\mu_m^k = 0.15 \text{ cm}^2/\text{g}$ and $\Delta\mu^\pm = 3.29 \text{ cm}^2/\text{g}$. For $3M$ nitric acid, this term has a value of -0.867 g Pu/L (effective). This correction and its fluctuations (due to molarity fluctuations from sample to sample) are quite significant for plutonium concentrations measured with a 0.5% precision in the 30-g-Pu/L range. As a result, in this type of assay situation, the acid molarity must be carefully controlled, or it must be measured and a correction applied to the matrix term for each assay.

II. STATISTICAL UNCERTAINTY IN THE DENSITOMETRY ASSAY RESULT

Regardless of the analysis method applied, the quoted uncertainties in ρ_{Pu} are dominated by the statistical fluctuations in the transmission measurements. For Case a above, we have

$$\sigma(\rho_{\text{Pu}})/\rho_{\text{Pu}} = (1/\rho_{\text{Pu}} \Delta\mu^x) \sigma(T_L/T_U)/(T_L/T_U) = \sigma_{\rho_{\text{Pu}}}^r(\text{stat}) \quad . \quad (\text{A-8})$$

The transmissions $T_{U,L}$ are the ratios of photopeak intensities, $I_{U,L}/I_{U,L}^{(o)}$, where the intensities in the denominator are the empty-cell (straight-through) values and those in the numerator are the solution values. The uncertainties in the intensities are just the square roots of the corresponding peak areas. Thus, assuming that the uncertainties in the empty-cell measurements are negligible compared to the full-cell measurements, we have

$$\sigma(T_L/T_U)/(T_L/T_U) = (1/I_U + 1/I_L)^{1/2} \quad . \quad (\text{A-9})$$

Using

$$I_L = I_L^{(0)} \exp[-(\rho_{Pu} \mu_{Pu} x + \rho_m \mu_m x)] ,$$

and assuming that

$$\mu_m^L = \mu_m^U ,$$

we have

$$\sigma_{\rho_{Pu}}^r(\text{stat}) = \sqrt{(1 + e^y)/I_L} / y , \quad (\text{A-10})$$

where $y = \rho_{Pu} \mu x$. This relationship is plotted in Fig. A-2 for $I_L^{(0)}$ equal to 2×10^6 counts. The curves in Fig. A-2 show that for a given ρ_{Pu} , a unique sample thickness exists for optimum precision in the concentration measurement. At progressively higher concentrations than shown in the plot, smaller cell thicknesses are called for. Otherwise, excessive attenuation of photon intensity begins to cause severe deterioration of the counting statistics.

It should be noted that the assumptions made in the discussion above were simplifying approximations for the purpose of pointing out the salient features of the densitometry precision prediction. In the actual data analysis, the predicted statistical precision for each assay is computed from the measured counting rates in the gamma-ray peaks of interest. All relevant photopeaks are considered, including the straight-through intensities.

In Case c, where the transmissions are extrapolated to the plutonium K edge, the relative uncertainty in the slope parameter m (σ_m^r) introduces further uncertainty in ρ_{Pu} , which is added in quadrature to the relative statistical uncertainty

$$\sigma_{\rho_{Pu}}^r(\text{tot})^2 = \sigma_{\rho_{Pu}}^r(\text{stat})^2 + w^2 (\sigma_m^r)^2 , \quad (\text{A-11})$$

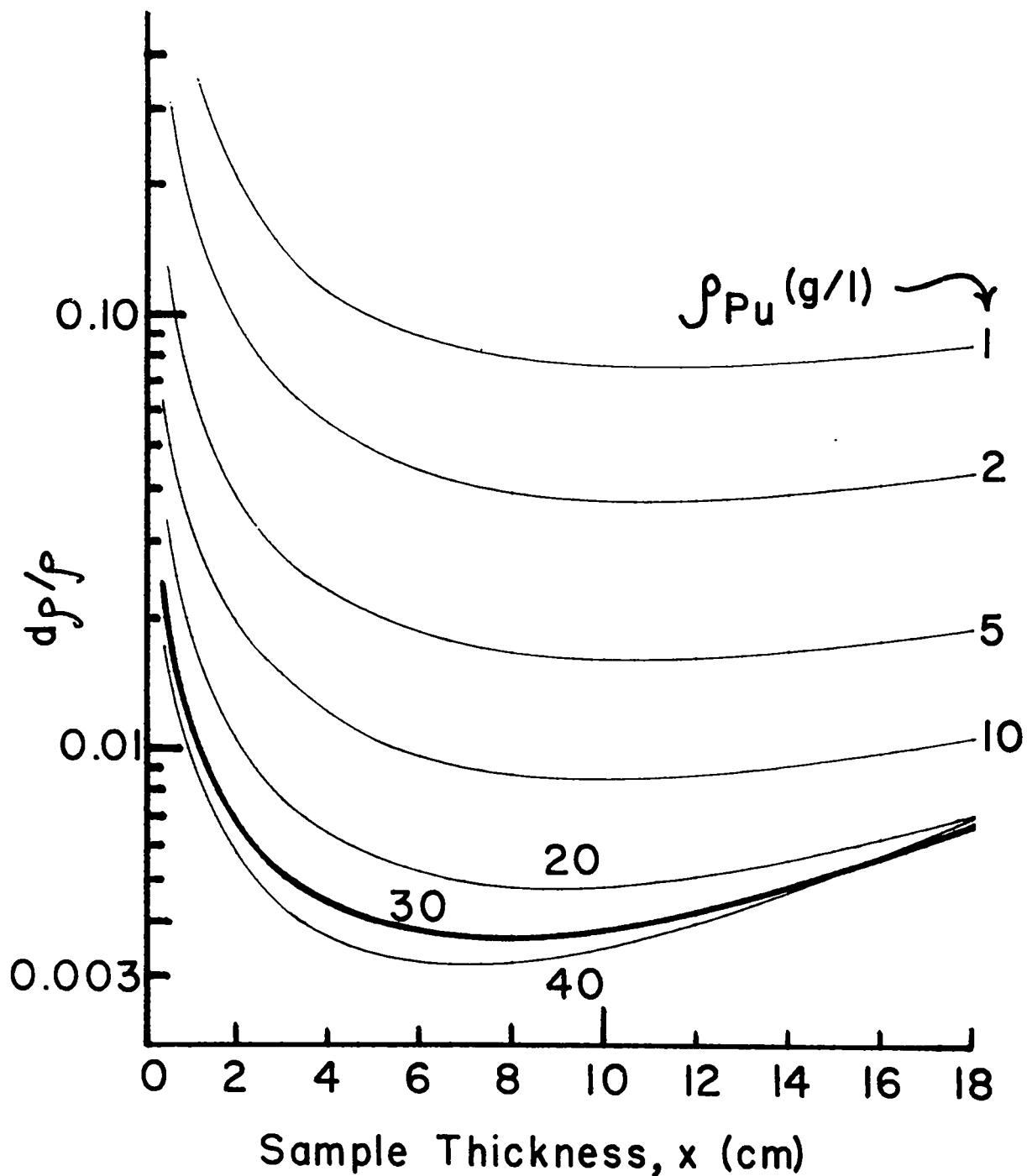

Fig. A-2. Relative statistical uncertainty in the plutonium concentration measurement by K-edge densitometry as a function of sample-cell thickness (transmission path length). Curves are shown for several plutonium concentrations and were obtained under count rate assumptions consistent with the conditions encountered at the Savannah River Plant. In particular, the empty-cell transmission count rate below the plutonium K edge was taken as 2×10^6 counts in the 121.1-keV photopeak. This corresponds to the result obtained with a 20-kc detector count rate and 1000-s spectrum count times.

where w , which depends upon the constants E_L , E_U , m , and the transmissions T_U and T_L , has a value of approximately 0.015. Thus, a 10% uncertainty in m adds (in quadrature) a 0.15% uncertainty in ρ_{PU} .



APPENDIX B

PLUTONIUM ISOTOPIIC ANALYSIS

I. DETERMINATION OF ISOTOPIIC WEIGHT FRACTIONS

The isotopic ratios that are measured in each sample are $^{238}\text{Pu}/^{239}\text{Pu}$ and $^{241}\text{Pu}/^{239}\text{Pu}$, where A_{Pu} stands for the weight fraction of the plutonium isotope with nuclear mass number A (A = 238 to 242). These ratios are determined through the measurement of the photopeak area ratios: I(153 keV)/I(129 keV) and I(148 keV)/I(129 keV), respectively (Fig. 3 in main text). The actual isotopic ratios are computed from the following relationships:

$$R_1 = (^{238}\text{Pu}/^{239}\text{Pu}) = \alpha \cdot \epsilon(129/153) \cdot I(153 \text{ keV})/I(129 \text{ keV}) \quad (\text{B-1})$$

and

$$R_4 = (^{241}\text{Pu}/^{239}\text{Pu}) = \beta \cdot \epsilon(129/148) \cdot I(148 \text{ keV})/I(129 \text{ keV}) \quad , \quad (\text{B-2})$$

where α and β are constants which depend upon the nuclear properties of the isotopes,¹⁰

$$\alpha = (\lambda_{239}/\lambda_{238}) \cdot B(129)/B(153) \cdot (238/239) = 0.02387 \quad (\text{B-3})$$

and

$$\beta = (\lambda_{239}/\lambda_{241}) \cdot B(129)/B(148) \cdot (241/239) = 0.02012 \quad . \quad (\text{B-4})$$

The quantity λ_A is the total decay probability of the isotope with mass number A, and the quantity $B(E_\lambda)$ is the branching fraction of the gamma transition of energy E_λ in the decay of the isotope in question.¹⁰ The quantity $\epsilon(E_1/E_2)$ is the relative detection efficiency of the system for gamma energies E_1 and E_2 . These relative efficiencies are determined during calibration by measurement of samples with known values of R_1 and R_4 . The values of these efficiencies are stored in the permanent data file for use in all subsequent assays. The values of the raw peak areas are also corrected for self-attenuation in the sample solution through use of transmission data on the 122.1-, 136.0-, and 279.4-keV gamma rays taken during the densitometry measurement (Table II in the main text).

In a given sample assay, once R_1^a and R_4 are determined, a ^{239}Pu weight fraction is postulated, and the $^{240}\text{Pu}/^{239}\text{Pu}$ ratio is computed from the isotopic correlation,

$$R_3 = \frac{^{240}\text{Pu}}{^{239}\text{Pu}} = a_{240} \cdot (1 - b_{240} \frac{^{239}\text{Pu}}{^{240}\text{Pu}}) \quad (\text{B-5})$$

The constants a_{240} and b_{240} are determined from existing isotopic data, and for the samples dealt with here have the values

$$a_{240} = 0.9841$$

and

(B-6)

$$b_{240} = 1.0020 \quad .$$

The ^{242}Pu weight fraction is also determined from an isotopic correlation of the form

$$R_5 = {}^{242}\text{Pu}/{}^{239}\text{Pu} = a_{242} R_3^2 - b_{242} R_3 \quad , \quad (\text{B-7})$$

with

$$a_{242} = 0.2982$$

and

$$b_{242} = 0.0116 \quad . \quad .$$

If all of the above ratios are correct (that is, self-consistent), then their sum (with $R_2 = {}^{239}\text{Pu}/{}^{239}\text{Pu} = 1$) should equal the inverse of the ${}^{239}\text{Pu}$ weight fraction. That is,

$$\sum_{i=1}^5 R_i = T = 1/{}^{239}\text{Pu} \quad . \quad (\text{B-8})$$

This is mathematically equivalent to requiring that the sum of the absolute weight fractions equals 1.0. If $1/T$ does not equal the postulated ${}^{239}\text{Pu}$ weight fraction to within 10^{-8} , then $1/T$ is postulated as the new ${}^{239}\text{Pu}$ weight fraction and the computations are repeated. This procedure usually converges within 100 iterations. The procedure has been tested with a variety of initial guesses for ${}^{239}\text{Pu}$ and has been verified to converge to the same answer in all cases.

II. QUOTED UNCERTAINTIES IN THE ISOTOPIC RESULTS

The uncertainties in the measured ratios, R_1 and R_4 arise from statistical factors and an assigned 1% uncertainty in the sample self-attenuation

correction. The uncertainties are typically in the range of 18 and 1.5%, respectively (Fig. 9 in main text) for the solution concentrations encountered by this instrument. The uncertainties in R_3 and R_5 reflect the precision of the respective isotopic correlations and have typical values of 2.5 and 40% of the estimated values, respectively. The uncertainty in the ^{239}Pu weight fraction is computed from the highly correlated uncertainties in R_1 , R_3 , R_4 , and R_5 and is quoted as approximately 0.2%.

REFERENCES

1. T. R. Canada, S.-T. Hsue, D. G. Langner, E. R. Martin, J. L. Parker, T. D. Reilly, and J. W. Tape, "Applications of the Absorption-Edge Densitometry NDA Technique to Solutions and Solids," *Nucl. Mater. Manage.* Fall 1977, p. 702 (1977).
2. T. R. Canada, D. G. Langner, and J. W. Tape, "Nuclear Safeguards Applications of Energy Dispersive Absorption-Edge Densitometry," *Nuclear Safeguards Analysis*, E. A. Hakkila, Ed., ACS Symposium Series No. 79, p. 95 (1978).
3. L. R. Cowder, S.-T. Hsue, S. Johnson, J. Parker, P. Russo, J. Sprinkle, Y. Asakura, T. Fukuda, and I. Kondo, "An Instrument for Measurement of Plutonium Concentration and Isotopics of Product Solutions at Tokai-Mura," *Proc. Second Annual Symp. on Safeguards and Nuclear Material Management, Edinburgh, Scotland, March 26-28, 1980* (European Safeguards Research and Development Association, Brussels, 1980), p. 119.
4. P. A. Russo, S.-T. Hsue, D. G. Langner, and J. K. Sprinkle, "Nuclear Safeguards Applications of Energy-Dispersive Absorption-Edge Densitometry," presented at the Annual Meeting of the Institute of Nuclear Materials Management, Palm Beach, Florida, June 30-July 2, 1980.
5. H. A. Smith, Jr., T. Marks, L. Cowder, C. Shonrock, S. Johnson, R. Slice, J. Sprinkle, K. MacMurdo, R. Pollard, and L. Baker, "Development of In-Line Plutonium Solution NDA Instrumentation at the Savannah River Plant," *Proc. Second Annual Symp. on Safeguards and Nuclear Material Management, Edinburgh, Scotland, March 26-28, 1980* (European Safeguards Research and Development Association, Brussels, 1980) p. 123.
6. P. A. Russo, T. R. Canada, D. G. Langner, J. W. Tape, S.-T. Hsue, and L. R. Cowder, "An X-Ray L_{III} -Edge Densitometer for Assay of Mixed S.N.M. Solutions," *Proc. Second Annual Symp. on Safeguards and Nuclear Material Management, Edinburgh, Scotland, March 26-28, 1980* (European Safeguards Research and Development Association, Brussels, 1980), p. 235.
7. J. E. Rein, S. F. Marsh, G. C. Swanson, G. R. Waterbury, G. L. Tietjen, and R. K. Zeigler, "Preparation of Working Calibration and Test Materials:

Plutonium Nitrate Solution," Los Alamos Scientific Laboratory report LA-NUREG-6348 (January 1977).

8. R. C. Weast, Ed., "Handbook of Chemistry and Physics," 55th edition (Chemical Rubber Co. Press, 1975).
9. E. Storm and H. I. Israel, "Photon Cross Sections from 0.001 to 100.0 MeV for Elements 1 through 100," Los Alamos Scientific Laboratory report LA-3753 (1967).
10. C. M. Lederer and V. S. Shirley, Ed., "Table of Isotopes," 7th edition (John Wiley and Sons, New York, 1978).

Printed in the United States of America
 Available from
 National Technical Information Service
 US Department of Commerce
 5285 Port Royal Road
 Springfield, VA 22161
 Microfiche \$3.50 (A01)

Page Range	Domestic Price	NTIS Price Code	Page Range	Domestic Price	NTIS Price Code	Page Range	Domestic Price	NTIS Price Code	Page Range	Domestic Price	NTIS Price Code
001-025	\$ 5.00	A02	151-175	\$11.00	A08	301-325	\$17.00	A14	451-475	\$23.00	A20
026-050	6.00	A03	176-200	12.00	A09	326-350	18.00	A15	476-500	24.00	A21
051-075	7.00	A04	201-225	13.00	A10	351-375	19.00	A16	501-525	25.00	A22
076-100	8.00	A05	226-250	14.00	A11	376-400	20.00	A17	526-550	26.00	A23
101-125	9.00	A06	251-275	15.00	A12	401-425	21.00	A18	551-575	27.00	A24
126-150	10.00	A07	276-300	16.00	A13	426-450	22.00	A19	576-600	28.00	A25
									601-up	†	A99

†Add \$1.00 for each additional 25-page increment or portion thereof from 601 pages up.

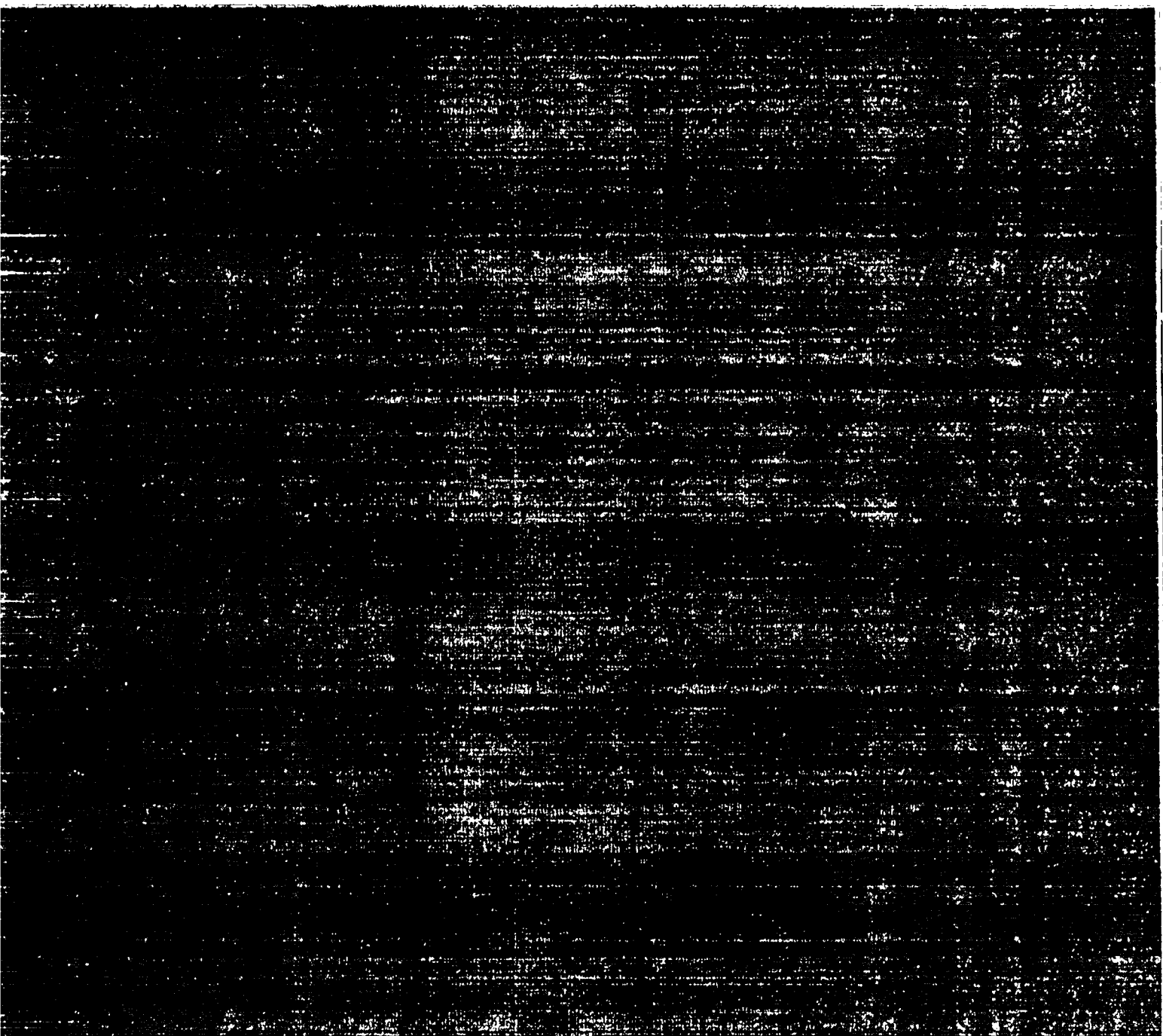

Los Alamos